

## Product Brochure For S912GL

### Hydraulic NC Pressbrake - PB-200B

200T x 4000mm - Includes Laser Safety Guarding

Estun NC-E21 Control 2-Axis with Hardened Ballscrew Backgauge & Table Crowning

**On Sale**

Ex GST

Inc GST

**\$74,970.00**

**\$86,215.50**

**\$72,000.00**

**\$82,800.00**



ORDER CODE:	S912GL
MODEL:	PB-200B
Control Unit (Type):	Estun NC-E21
Nominal Pressure - Tonnage (Ton):	220
Nominal Pressure - Kilonewtons (kN):	2000
Length of Work Table (mm):	4000
Distance Between Columns (mm):	3200
Throat Depth (mm):	420
Maximum Open Height (mm):	450
Ram Stroke (mm):	200
Machine Axis (No.):	2
Safety Guarding System (Type):	Laser System
Backgauge Travel (mm):	550
Table Bed Crowning System (Type):	Mechanical Crowning System
Motor Power (kW / hp):	15 / 20
Motor Voltage (V):	415
Floor Space Requirements (L x W x H) (mm):	4700 x 2300 x 3000
Nett Weight (kg):	16500

METALMASTER



### Description

MetalMaster Quality Pressbrakes feature high durability, and provide precision bending capabilities. The Pressbrake main frames are constructed from rolled, stress relieved solid steel to prevent distortion during the bending process and under extreme continuous loads.

MetalMaster Pressbrakes are produced in a high volume production process and therefore are able to be manufactured cost effectively, resulting in an affordable price, representing value for money and quicker return on investment.

All electrical components are of European quality supplied by, Telemecanique, Merlin Gerin and ABB.

### Features

- ESTUN E21 NC Controller
- Stores up to 40 programs with 25 bending steps per program
- Position control of Backgauge
- Backgauge retract function
- Bottom stroke dwell timer
- Work piece counting
- One-key backup / restore
- LCD Display
- LASER GUARDING -
- Laser guarding provides close proximity operator protection allowing faster bending cycles, promoting higher productivity
- The Laser system is compliant with requirements of EN61496-1, EN61496-2, ISO 13849-1 Ple, as well as AS/NZS 4024.1503
- Australian designed electrical system featuring dual channel monitoring on all essential machine functions
- Top beam speed & stopping performance are all real time monitored to ensure compliance with safety regulations
- METALMASTER Pressbrakes -
- Dual Hydraulic rams balanced by a heavy duty torsion bar, Electronically controlled by the E21 NC control assuring accuracy & repeatability.
- High performance side mount back gauge with linear guides & ballscrew provides fast and accurate positioning
- Segmented heavy duty 86° top punch
- European style punch holder with an adjustable wedge clamping system for crowning
- Multi vee ('V') bottom die is made from one solid 4000mm die block design to handle heavy plate, safety edge vee ('V') is incorporated in bottom die block.
- Sliding steel fabricated sheet supports enabling a wide range of material sizes to be aligned and supported at the correct required height.

## Product Brochure For S912GL

---

This feature is achieved with a "T" slot machined down the total length of the die bed, sheet supports are also adjustable vertically to assist in supporting material with return bends already folded.

- Metal safety guarding surrounding the machine with rear sliding door fitted with micro switch ensuring operator safety.
  - Hydraulic pressure gauge with quick adjust pressure control & over pressure protection allows the operator to accurately set the pressure required for different material thickness.
  - The vertical supporting slides are treated to provide greater wear resistance and increased accuracy.
  - Reinforced side frames providing addition support strength to machine throat
  - Includes laser guarding system
  - Mild steel capacity is rated on hot rolled material with 250MPA
- 
- Pre-Commissioning:
    1. Pressbrake is run & tested prior delivery
    2. Hydraulic oil is included with machine

### **Includes**

- ESTUN NC- E21 control mounted on a swivel pendant for optimal ergonomics
- LED superior bright work lights provides clearer view to workpiece
- Sliding front sheet support arms
- Manual bed crowning system
- Mobile dual operation foot control
- 86 Degree Top Punch with Segments (4x800, 1x365, 1x200, 1x100, 1x50, 1x40, 1x20, 1x15, 1x10)
- Top tooling tool intermediate holder system with wedge type adjustment
- Multi V bottom die block 130 x 130mm with a range of V's between 8mm~100mm
- Premium side mount linear way ballscrew backgauge with 550mm travel
- Metal constructed safety guarding surrounding machine

## **GL Model: Laser guarding safety**

- 1. Laser guarding provides close proximity protection allowing faster bending cycles higher productivity.**
- 2. The Laser system is compliant with requirements EN61496-1, EN61496-2, ISO 13849-1 PL3 AS/NZS 4024.1503**
- 3. Australian designed electrical system for channel monitoring on all essential machines**
- 4. Top beam speed & stopping performance monitored to ensure compliance with safety standards**

Product Brochure For S912GL

**Specific Features**

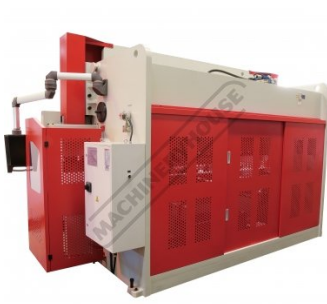

Enclosed Rear Safety Guarding



NC Estun E21 Controller



NC Estun E21



Left Laser



Right Laser

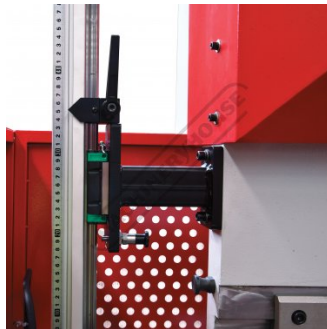

Laser Alignment Guide



Adjustable Travel Limit Control



Laser Guarding system In Use

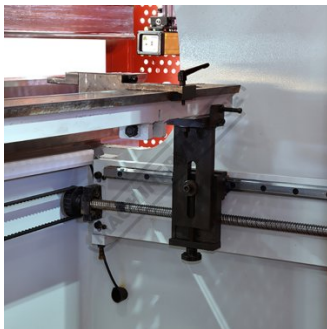

LM Guide Ballscrew Backgauge

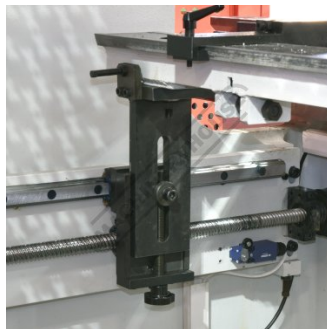

LM Guide Ballscrew Backgauge

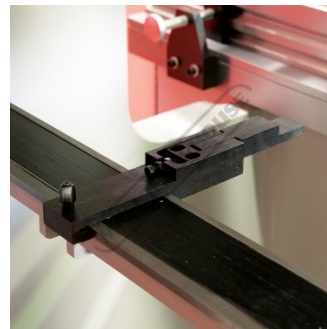

Backgauge Material Stops



Top and Bottom Tooling



Intermediate Clamps



Adjustable Top Tool Taper Wedge System

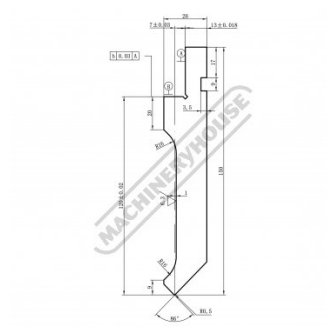

Segmented Top Punch

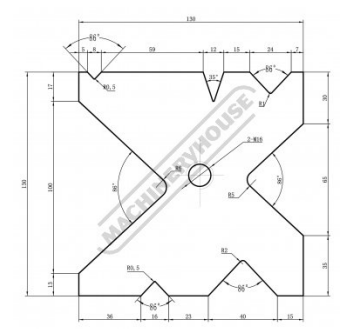

One Piece 4 Sided Die

Product Brochure For S912GL



Table Crowning Adjustment via Bolts



Table Crowning Adjustment Bolts

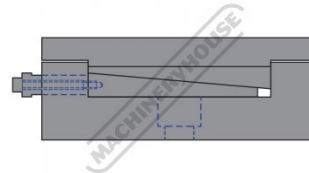
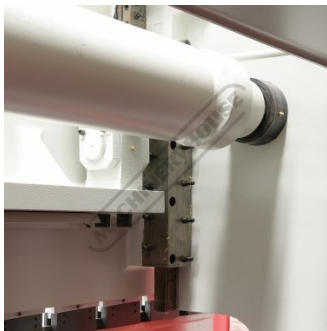

Table Bed Crowning



Sheet Supports



Torsion Bar



Mobile Foot Control



Mobile Control Panel

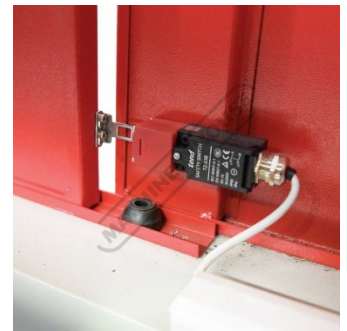

Rear Doors Safety Micro Switch



Adjustable Pressure Gauge

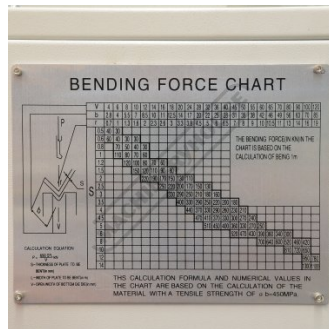

## Product Brochure For S912GL

### Recommended Accessories

**S991**

86° Top Punch Pressbrake Tooling



**S991S**

86° Top Punch Pressbrake Tooling - Segmented



**S991F**

86° Top Punch Pressbrake Tooling



**S994A**

130mm Die Block Pressbrake Tooling

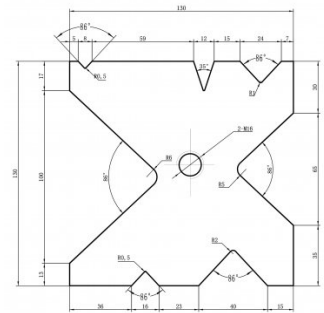

**S995**

150mm Die Block Pressbrake Tooling

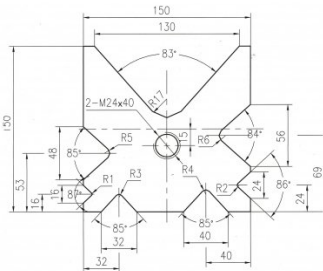

**S9920**

86° Top Punch Gooseneck Pressbrake Tooling



**S9920S**

86° Top Punch Gooseneck Pressbrake Tooling - Segmented

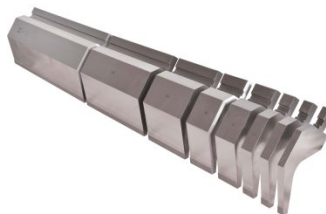

**Q201**

Universal Bevel Protractor



Product Brochure For S912GL

---

**M800**  
Rubber Mat - Anti-Fatigue



**M805**  
Rubber Mat - Anti-Fatigue

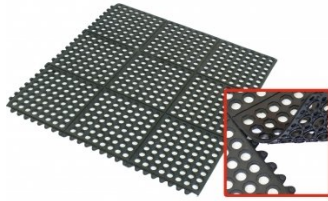

**O043**  
Rust & Corrosion Preventive



**O042**  
General Purpose Lubricant & Corrosion Inhibitor



**O044**  
Rust & Corrosion Preventive

