

## Product Brochure For S901G

### Hydraulic NC Pressbrake - PB-70E

70T x 3200mm - Includes Light Curtain Safety Guarding  
Estun NC-E21 Control 2-Axis with Leadscrew Backgauge



ORDER CODE:	S901G
MODEL:	PB-70E
Control Unit (Type):	Estun NC-E21
Nominal Pressure - Tonnage (Ton):	70
Nominal Pressure - Kilonewtons (kN):	630
Length of Work Table (mm):	3200
Distance Between Columns (mm):	2600
Throat Depth (mm):	260
Maximum Open Height (mm):	355
Ram Stroke (mm):	90
Machine Axis (No.):	2
Safety Guarding System (Type):	Light Curtain System
Backgauge Travel (mm):	520
Table Bed Crowning System (Type):	-
Motor Power (kW / hp):	7.5 / 10
Motor Voltage (V):	415
Floor Space Requirements (L x W x H) (mm):	3900 x 2000 x 2580
Nett Weight (kg):	5000



#### Description

Metalmaster Press brakes are designed and tested to provide precision bending capabilities demanded in industry. The main structural frames are constructed from rolled, stress relieved solid steel to prevent distortion during the bending process and under extreme continuous loads.

Featuring a heavy duty adjustable torsion bar with a positive stop system ensures consistent and accurate bending.

All electrical components are of European quality supplied by leading brands such as Siemens, Schneider, Telemecanique, Merlin Gerin and ABB.

Note: Guarding systems are required on pressbrakes for OHS compliance.

#### Features

- Hydraulic synchronised positive stop design, the ram stroke is controlled by a precision mechanical nut depth stop built into each cylinder, electronically controlled by Estun NC-E21 digital control assuring accuracy and repeatability.
- Mono-block steel frame design, welded, stress relieved and final machining ensures minimal bed deflection under load.
- Bending Parallelism is ensured by the oversize top beam and heavy duty torsion bar.
- Conveniently mounted control box on pendant for quick swivel and adjustments.
- Estun NC-E21 programmable digital control stores up to 40 unique programs with 25 automatic progressive bending steps in each individual program, assuring production accuracy & repeatability every time.
- Estun NC-E21 programmable leadscrew back gauge system, simply enter the desired measurement into the controller and press start, the back gauge then will move quickly into the position you have requested.
- Operator adjustable stroke open height & mute height switches enables increased productivity
- Adjustable bending pressure control allows the operator to quickly and accurately set the pressure required for different material. This user friendly system incorporates hydraulic overload protection.
- European style Intermediate top tool clamping system, featuring an adjustable wedge clamping system for crowning as well as a safety key to stop the punch dropping when changing punch positions.
- Segmented heavy duty 86° offset top punch is segmented for selective bend width applications and offset for return bend clearance.
- Multi vee ('V') bottom die is made from one 3200mm solid die block design to handle heavy plate, safety edge vee ('V') is incorporated in bottom die block.
- Sliding front material sheet supports enabling a wide range of material sizes to be aligned and supported at the required height. This feature is achieved with a "T" slot machined down the total length of the die bed; sheet supports are also adjustable vertically to assist in supporting material with return bends already folded.
- Rear sliding safety gate with micro switch combined with access panels placed at each end of machine allows the operator to clearly view tooling and work piece during the bending operation, Metalmaster specially design gates to suit Australian safety requirements
- The vertical top beam slides are treated to provide greater wear resistance and increased accuracy.

## Product Brochure For S901G

- Mild steel capacity is rated on hot rolled material with 250MPA

- Pre-Commissioning:
  1. Press brake is run & tested prior delivery
  2. Hydraulic oil is included with machine

### Includes

- ESTUN NC- E21 control mounted on a swivel pendant for optimal ergonomics
- Adjustable front sheet support arms
- Emergency stop buttons strategically located on control panel and foot control
- Mobile dual operation foot control
- Segmented 86° offset top punch tooling
- Solid one piece four way multi vee (V) die block
- Top tooling tool intermediate holder system with wedge type adjustment
- Powered leadscrew back gauge with 520mm travel, operated by Estun NC-E21 control
- Oil tank level indicator
- Metal constructed safety guarding
- Integrated hydraulic system allowing rapid approach speed switching automatically to slow bend

### Specific Features



Right View



Enclosed Rear Safety Guarding



NC Estun E21 Controller



NC Estun E21



Mobile Foot Control

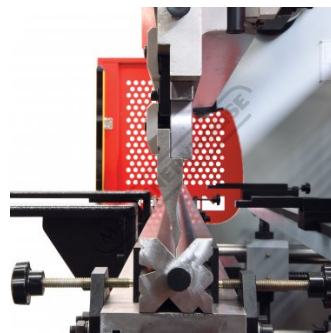

Top And Bottom Tooling



Intermediate Clamps



Adjustable Top Tool Taper Wedge System



Adjustable Front Sheet Supports



Tooling Bed Clamps



Safety Guarding



Estun NC E21 Control Ballscrew Backgauge

Product Brochure For S901G



Estun NC E21 Control Ballscrew Backgauge 2



Backgauge Stops



Synchronised Torsion Bar



Adjustable Pressure Control

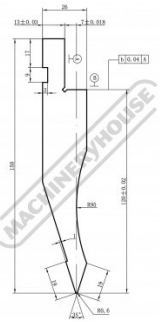

Segmented Top Punch

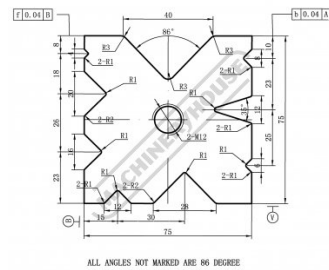

One Piece 4 Sided Die

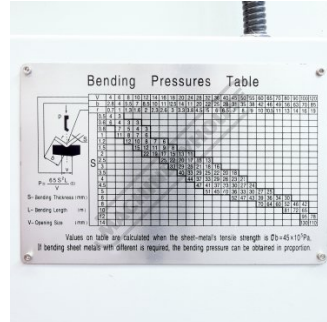

Tonnage Calculation Chart

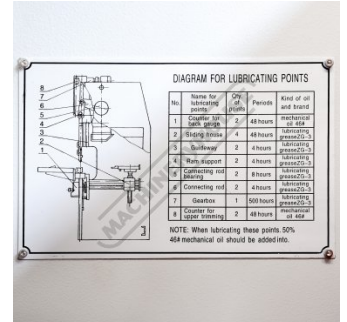

Lubrication Chart

**Recommended Accessories**

S988

Quick Action Intermediate Clamps



S990S

35° Top Punch Pressbrake Tooling - Segmented



S990

35° Top Punch Pressbrake Tooling



S990F

35° Top Punch Pressbrake Tooling



Product Brochure For S901G

**S9927**  
75mm Die Block Pressbrake Tooling

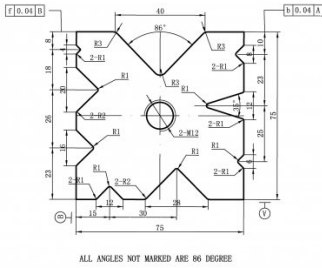

**S991S**  
86° Top Punch Pressbrake Tooling - Segmented



**S991**  
86° Top Punch Pressbrake Tooling



**S996**  
15° Top Punch Pressbrake Tooling



**S996A**  
60mm Die Block Pressbrake Tooling

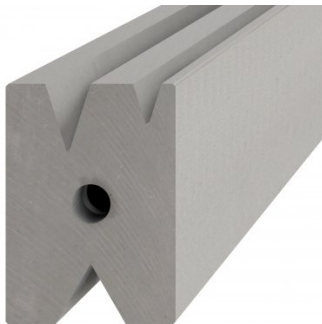

**S996B**  
60mm Die Rail Pressbrake Tooling



**Q200**  
Combination Set

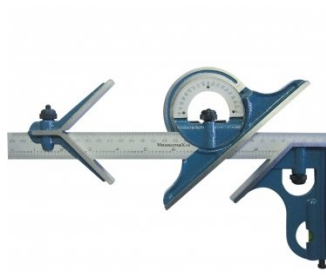

**Q200A**  
Combination Set

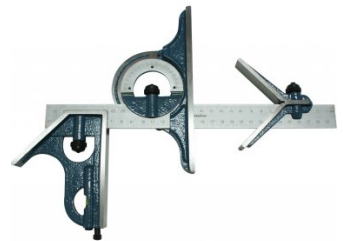

**Q201**  
Universal Bevel Protractor



**Q2105**  
Digital Height Gauge



**M970**  
Digital Angle Rule



**M972**  
Digital Angle Rule



Product Brochure For S901G

M974  
Digital Angle Rule



M800  
Rubber Mat - Anti-Fatigue



M805  
Rubber Mat - Anti-Fatigue

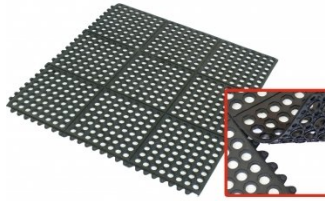

O043  
Rust & Corrosion Preventive



O042  
General Purpose Lubricant &  
Corrosion Inhibitor



O044  
Rust & Corrosion Preventive

