

Product Brochure For R004

Vertex Super Indexing Head - CS-8

155mm Centre Height
Ø63mm Bore



Description

Manufactured in Taiwan

Features

- The Vertex Super Spacer is designed to be used on milling, drilling or any machine where an indexing facility is required
- Combines the advantages of super indexing with the flexibility of worm gear movement
- The 3-jaw chucks on both the 6" and 8" models have large through-bores
- Can be used in either vertical or horizontal plane
- Master indexing plate has 24 divisions and is permanently fixed inside the indexer. Divisions of 2, 3, 4, 6, 8 & 12 can also be achieved by using sub plates. These can be installed quickly in the bottom of the indexer
- When the chuck is removed, the unit can be used as a horizontal or vertical rotary table
- The worm gear has a ratio of 90:1. It can be dis-engaged for quick indexing work
- Worm is hardened and precision ground to minimise wear
- The operating collar is graduated in one minute increments and readings down to ten seconds can be set on the vernier scale
- The unit can be fitted with dividing plates

Includes

- 200mm 3-Jaw Self-Centring Chuck
- Face Plate
- 6 indexing plates

On Sale

Ex GST	Inc GST
\$2,306.00	\$2,651.90
\$1,847.83	\$2,125.00

ORDER CODE:	R004
MODEL:	CS-8
3 Jaw Chuck Size (mm):	Ø203
Bore (mm):	Ø63
A (mm):	310
B (mm):	285
C (mm):	243
a (mm):	225
b (mm):	160
c (mm):	201
d (mm):	82
e (mm):	125
f (mm):	75
g (mm):	16
h (mm):	155
i (mm):	232
j (mm):	90
K (mm):	18
Nett Weight (kg):	76

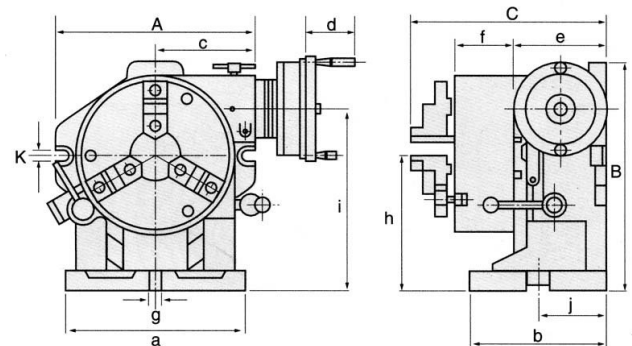

Product Brochure For R004

Recommended Accessories

R020

Vertex Dividing Plate

R015

Vertex Tailstock

