

Product Brochure For Q322

Metric Outside Micrometer - Large Cast Frame - 12-322

225 - 250mm Range



ORDER CODE:	Q322
Range (mm):	225 - 250
Graduation (mm):	0.01
Accuracy (mm):	0.008
Setting Bar (No.):	1
a (mm):	19.4
b (mm):	5.5
c (mm):	142
L (mm):	260
m061:	~

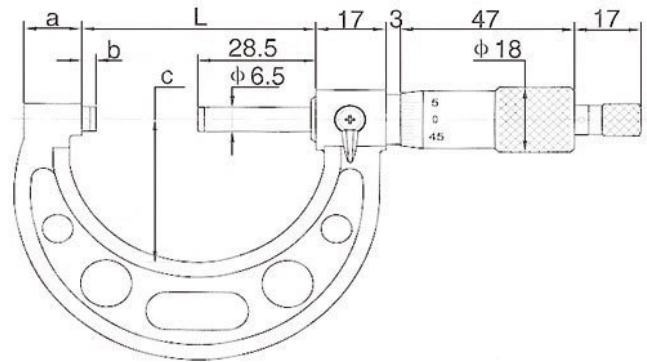

Description

Measumax metric micrometers represent exceptional value. Special care has been taken in design and workmanship to ensure high precision and long life. Measumax metric micrometers meet industry standards for specification and accuracy

Features

- Carbide measuring faces - Painted cast frame
- Micro-fine clear graduations on satin chrome finish
- Measuring face 6.5mm, Flatness 0.0008mm
- Ratchet stop for exact repetitive readings
- Includes deluxe foam lined plastic case and wrench
- Graduation 0.01mm
- Supplied with setting standards