

Product Brochure For Q215

Metric Dial Indicator - 34-215

0-30mm
Smooth movement

On Sale

Ex GST
\$104.00
\$82.61

Inc GST
\$119.60
\$95.00



ORDER CODE:	Q215
Range (mm / inch):	0 - 30mm
Graduations (mm / inch):	0.01mm
A (mm):	58
B (mm):	21
C (mm):	8
D (mm):	60
E (mm):	20
F (mm):	18
G (mm):	5
H (mm):	8



Features

- In-out tolerance maker
- Smooth movement
- Flat glass
- Flat back and back lug supplied
- Individual serial numbers with corresponding calibration certificate
- Supplied in foam lined plastic case

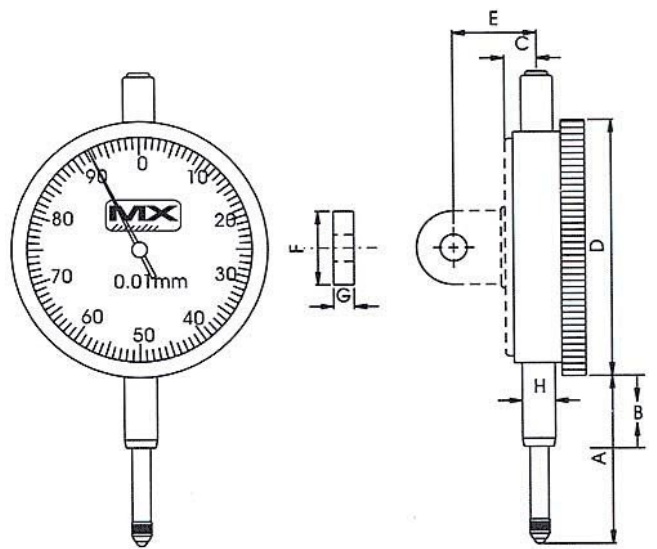

Product Brochure For Q215

Recommended Accessories

Q2165
Ø10mm Flat Contact for Dial Indicators



Q2167
Contact Point for Dial Indicators



Q2125
Back Plate with Lug for Dial Indicators



M050
Magnetic Base - Standard



M051
Magnetic Base - Deluxe - One Lock



Q430
Magnetic Base - Small



Q435
Magnetic Base - Large



Q4351
Magnetic Base - Large



Product Brochure For Q215

Q436

Magnetic Base - One Lock
(Large)

