

Product Brochure For Q125

Digital Outside Micrometer - 10-125

0-25mm / 0-1"

IP54 (Splash Proof)



ORDER CODE:	Q125
Range (mm / inch):	0 - 25mm / 0 - 1"
Accuracy (mm):	±0.002
C (mm):	23
L (mm):	32
Protection Rating:	IP54 (Splash Proof)
Direct RS-232 output (Yes / No):	No

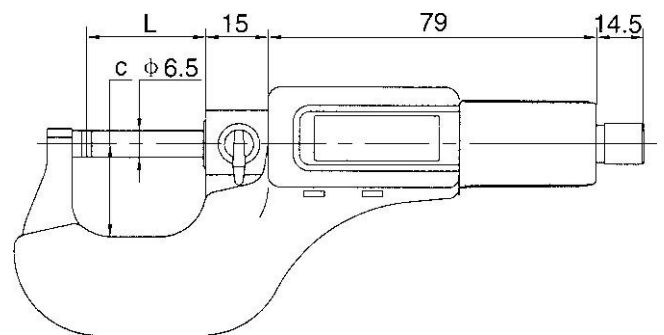

Description

Quick, accurate and easy to use with IP54 protection against oil, water and coolant. Measumax digital micrometers are robust enough for any situation where other regular digital micrometers fail

Features

- Protected to IP54 specifications
- Large LCD for easy reading
- Metric-imperial conversion and zero setting keys
- Direct RS-232 output (uses cable 40-400)
- Friction thimble for easy one hand use
- Chrome-plated frame. Carbide measuring faces
- Resolution: 0.001mm/0.0005"
- Criterion: DIN863/1, DIN40050/IEC529

Includes

- Includes LR44 battery