

Product Brochure For Q101

Imperial Outside Micrometer - 10-101

0 - 1" Range

On Sale

Ex GST

~~\$62.00~~

\$47.83

Inc GST

~~\$71.30~~

\$55.00



ORDER CODE:	Q101
Range (inch):	0 - 1"
Graduation (inch):	0.001"
a (mm):	9
b (mm):	3
c (mm):	28
L (mm):	32

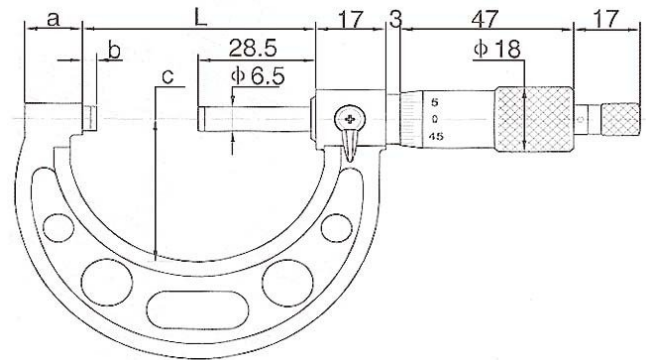

Description

Measumax imperial micrometers represent exceptional value with special care in design and workmanship to ensure high precision and long life.

Measumax imperial micrometers meet industry standards for specification and accuracy

Features

- Carbide measuring faces
- Measuring face 6.5mm, Flatness 0.0008mm
- Micro-fine clear graduations on satin chrome finish
- Ratchet stop for exact repetitive readings
- Includes deluxe foam lined plastic case and wrench
- Graduation 0.001"
- Painted cast frame
- Supplied with setting standards