

Product Brochure For P736

Ø36mm Round Punch - RPN2

Hi-Grade Tool Steel Imported From Japan

Ex GST
\$86.00

Inc GST
\$98.90

ORDER CODE:	P736
MODEL:	RPN2
Type:	Punch
Punch Diameter (D) (mm):	Ø36
Die Diameter (D) (mm):	~
Pack Quantity (No.):	1

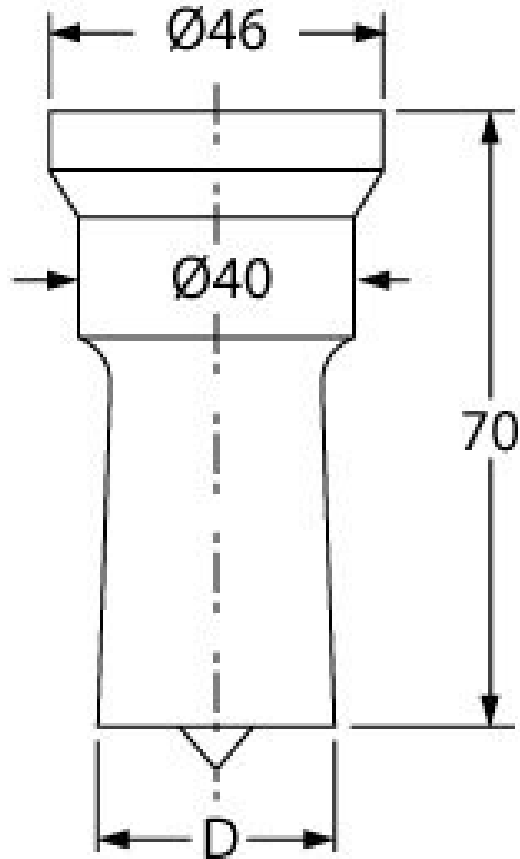

Description

Punch and Dies are Manufactured by Sunrise in Taiwan using Hi-Grade Tool Steel imported from Japan. The manufacturing process involves machining via hi tech CNC machines lathes & mills, vacuum heat treatment with multiple tempering at high temperatures before a final quality inspection/testing process all of which ensures an accurate, precise, durable & stable product.

Features

- PLEASE NOTE FOLLOWING RECOMMENDATIONS WHEN SELECTING DIE CLEARANCE:
- Material Thickness - 2 ~ 4mm = Die Clearance 0.2mm
- Material Thickness - 4 ~ 9.5mm = Die Clearance 0.7mm
- Material Thickness - 10 ~ 14.5mm = Die Clearance 1.2mm
- Material Thickness - 15 ~ 19.5mm = Die Clearance 1.7mm
- Material Thickness - 20 ~ 24mm = Die Clearance 2.2mm

Optional Accessories

- Other sizes and shapes available on request

Product Brochure For P736

Recommended Accessories

P736B
Ø36.2mm Round Die - RDN2



P736A
Ø36.7mm Round Die - RDN2



P737B
Ø37.2mm Round Die - RDN2



P737A
Ø37.7mm Round Die - RDN2



P738B
Ø38.2mm Round Die - RDN2



P738A
Ø38.7mm Round Die - RDN2



P739B
Ø39.2mm Round Die - RDN2

