

Product Brochure For P729

## Ø29mm Round Punch - RPN1

Hi-Grade Tool Steel Imported From Japan



### Description

Punch and Dies are Manufactured by Sunrise in Taiwan using Hi-Grade Tool Steel imported from Japan. The manufacturing process involves machining via hi tech CNC machines lathes & mills, vacuum heat treatment with multiple tempering at high temperatures before a final quality inspection/testing process all of which ensures an accurate, precise, durable & stable product.

### Features

- PLEASE NOTE FOLLOWING RECOMMENDATIONS WHEN SELECTING DIE CLEARANCE:
- Material Thickness - 2 ~ 4mm = Die Clearance 0.2mm
- Material Thickness - 4 ~ 9.5mm = Die Clearance 0.7mm
- Material Thickness - 10 ~ 14.5mm = Die Clearance 1.2mm
- Material Thickness - 15 ~ 19.5mm = Die Clearance 1.7mm
- Material Thickness - 20 ~ 24mm = Die Clearance 2.2mm

### Optional Accessories

- Other sizes and shapes available on request

Ex GST  
\$62.00

Inc GST  
\$71.30

ORDER CODE:	P729
MODEL:	RPN1
Type:	Punch
Punch Diameter (D) (mm):	Ø29
Die Diameter (D) (mm):	~
Pack Quantity (No.):	1

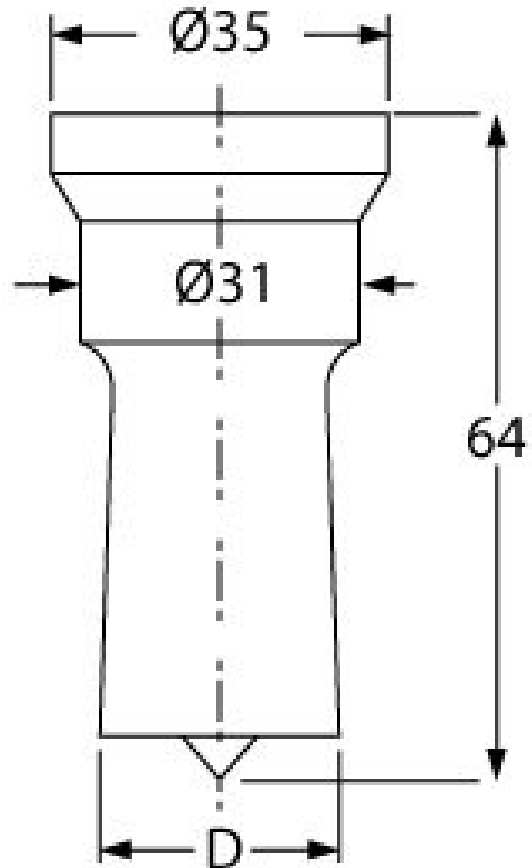

Product Brochure For P729

---

**Recommended Accessories**

P729B

Ø29.2mm Round Die - RDN1

P729A

Ø29.7mm Round Die - RDN1

P730B

Ø30.2mm Round Die - RDN1

P730A

Ø30.7mm Round Die - RDN1



P731B

Ø31.2mm Round Die - RDN1

P731A

Ø31.7mm Round Die - RDN1

