

Product Brochure For P716

## Ø16mm Round Punch - RPN1

Hi-Grade Tool Steel Imported From Japan

**On Sale**

Ex GST

**\$62.00**

**\$47.83**

Inc GST

**\$71.30**

**\$55.00**



ORDER CODE:	P716
MODEL:	RPN1
Type:	Punch
Punch Diameter (D) (mm):	Ø16
Die Diameter (D) (mm):	~
Pack Quantity (No.):	1



### Description

Punch and Dies are Manufactured by Sunrise in Taiwan using Hi-Grade Tool Steel imported from Japan. The manufacturing process involves machining via hi tech CNC machines lathes & mills, vacuum heat treatment with multiple tempering at high temperatures before a final quality inspection/testing process all of which ensures an accurate, precise, durable & stable product.

### Features

- PLEASE NOTE FOLLOWING RECOMMENDATIONS WHEN SELECTING DIE CLEARANCE:
- Material Thickness - 2 ~ 4mm = Die Clearance 0.2mm
- Material Thickness - 4 ~ 9.5mm = Die Clearance 0.7mm
- Material Thickness - 10 ~ 14.5mm = Die Clearance 1.2mm
- Material Thickness - 15 ~ 19.5mm = Die Clearance 1.7mm
- Material Thickness - 20 ~ 24mm = Die Clearance 2.2mm

### Optional Accessories

- Other sizes and shapes available on request

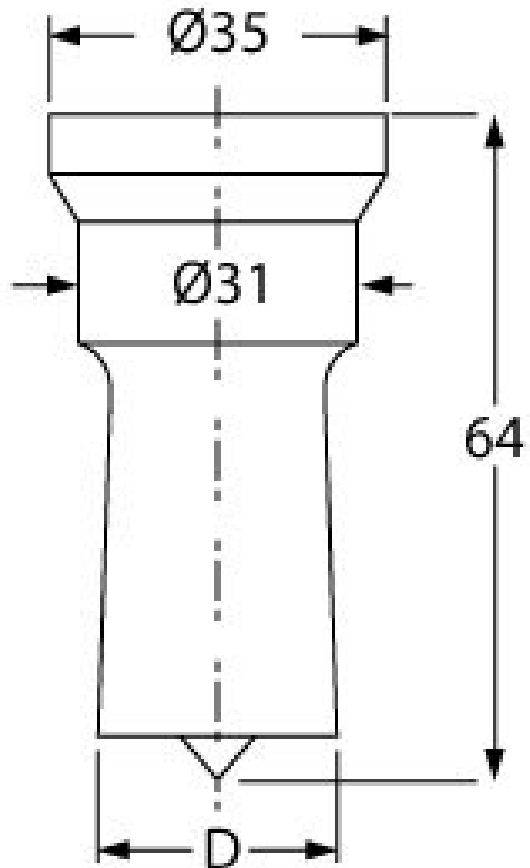

Product Brochure For P716

---

**Recommended Accessories**

P716B

Ø16.2mm Round Die - RDN1

P716A

Ø16.7mm Round Die - RDN1

P717B

Ø17.2mm Round Die - RDN1

P717A

Ø17.7mm Round Die - RDN1

