

Product Brochure For N005

Rivet Nut Inserts - M5 x 0.8mm

Steel - Zinc Plated
Qty 50 In Pack



Ex GST
\$14.00

Inc GST
\$16.10

ORDER CODE:	N005
MODEL:	-
Type:	Rivet Nut Inserts
Nut Insert Material (Type):	Steel - Zinc Coated
Quantity in Pack:	50
Rivet Nut Inserts Range (Metric):	-
Blind Rivets (mm):	-
Thread Size (T) (Metric):	M5 x 0.8
Thread Length (TL) (Metric):	-
Length (L) (mm):	11.8
Head Height (HH) (mm):	1.0
Head Diameter (HD) (mm):	9.95
Diameter (D) (mm):	6.9
Hole Size (HS) (mm):	7
Grip Range (GR) (mm):	0.25 - 2.50
Torque to Turn (Kgf.cm):	80

NUT INSERT



Description

Suits ATR-10RN Air Operated or RNB40 Twin Handle Nut Riveters

Features

- Steel - Zinc Coated
- Fast & easy installation from one side
- Adds a threaded nut to thin sheet metal
- Knurled section under nut head for anti-rotation
- Easy to install

Includes

- 50 x Rivet Nut Inserts - M5 x 0.8mm

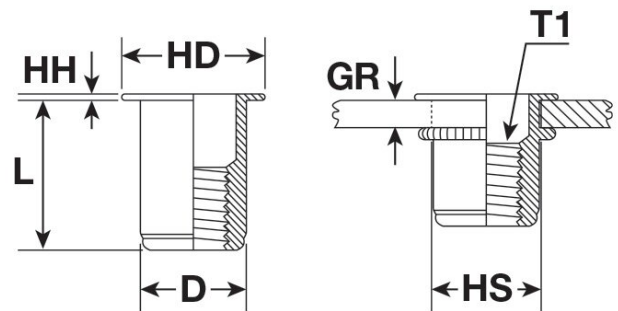

UNINSTALLED

INSTALLED

Product Brochure For N005

Specific Features



Packaging Front



Packaging Rear Side

Recommended Accessories

N001

Nut & Blind Riveter Set - 130 Piece

N006

Rivet Nut Inserts - M6 x 1.0mm

N008

Rivet Nut Inserts - M8 x 1.25mm

N010

Rivet Nut Inserts - M10 x 1.5mm



N015

Rivet Nut Inserts - M5 x 0.8mm

N016

Rivet Nut Inserts - M6 x 1.0mm

N018

Rivet Nut Inserts - M8 x 1.25mm

N020

Rivet Nut Inserts - M10 x 1.5mm

