

Product Brochure For M515

Face Mill 45° - Super High-Rake - F45SE12-D50

Ø50mm

Insert tip not included

On Sale

Ex GST

Inc GST

~~\$148.00~~

~~\$170.20~~

\$116.52

\$134.00



ORDER CODE:	M515
MODEL:	F45SE12-D50
Cutter Approach Angle (deg):	45°
D (mm):	50
D1 (mm):	64
H (mm):	40
d (lowercase):	22mm
Drawbar Thread:	-
Number of Inserts (No.):	4
Replacement Insert Tips:	(L065)
Nett Weight (kg):	0.60



Description

SUPER HIGH-RAKE FACE MILL - 50mm x 45°
Use carbide inserts (ISO) SEKT1204 (L065)
NOTE: Carbide Inserts not included

Features

- Suitable for low horsepower machines where rapid metal removal is required.
- Suitable for steel, cast iron and non-ferrous metals
- Positive rake

Includes

- Lock key for insert

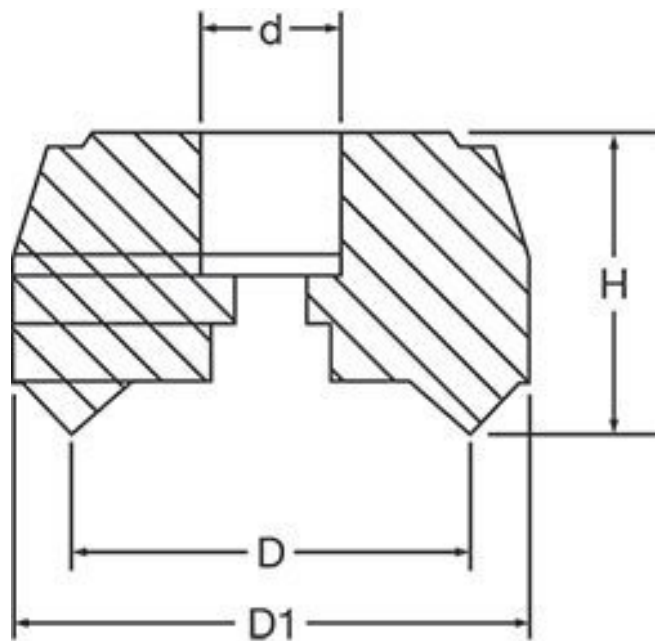

Product Brochure For M515

Recommended Accessories

L065
KYOCERA Carbide Inserts -
Milling



ML090
Cutter Part - Screw



L538
Key to Suit Tool Holder



M562
Face Mill Arbor



M535
Face Mill Arbor



M540
Face Mill Arbor



M550
Face Mill Arbor



T150
BT40-FMB22-45 Face Mill Arbor



Product Brochure For M515

T151

BT40-FMB22-90 Face Mill Arbor

