

Product Brochure For M171

NT40-MT3-70 Milling Adaptor



On Sale

Ex GST	Inc GST
\$98.00	\$112.70
\$77.39	\$89.00

ORDER CODE:	M171
MODEL:	NT40-MT3-70
Outer Taper:	NT40
Inside Taper:	MT3
Drawbar Thread (mm / inch):	16mm
L (mm):	70
C (mm):	40
Nett Weight (kg):	1.10

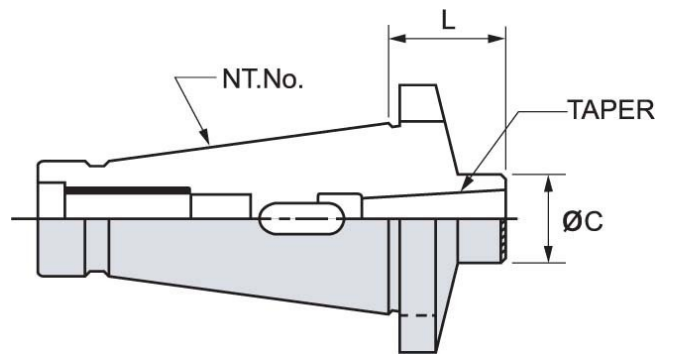

Description

Precision ground and hardened.
Morse taper adaptors are used to adapt a Morse taper tool or cutter to any spindle taper