

Product Brochure For M169

R8-MT2-30 Milling Adaptor



On Sale

Ex GST	Inc GST
\$56.00	\$64.40
\$43.48	\$50.00

ORDER CODE:	M169
MODEL:	R8-MT2-30
Outer Taper:	R8
Inside Taper:	MT2
Drawbar Thread (mm / inch):	7/16"
L (mm):	30
C (mm):	32
Nett Weight (kg):	0.40

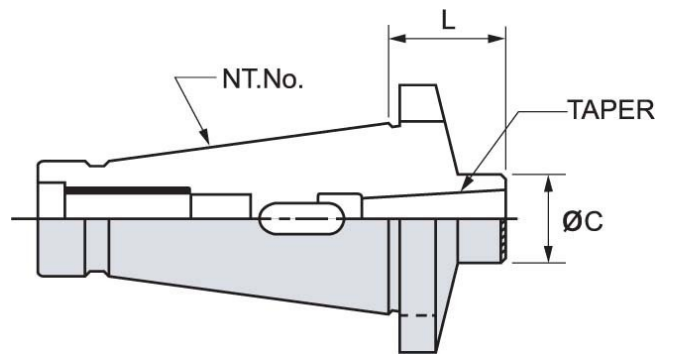

Description

Precision ground and hardened.
Morse taper adaptors are used to adapt a Morse taper tool or cutter to any spindle taper