

Product Brochure For L280

Quick Change Toolpost - QA-100

75 - 115mm Lathe Centre Height



On Sale

Ex GST
\$244.00
\$194.78

Inc GST
\$280.60
\$224.00

ORDER CODE:	L280
MODEL:	QA-100
Lathe Centre Height (mm):	75 - 115
Lathe Swing (mm):	150 - 230
A (mm):	12
B (mm):	6
C (mm):	50
D (mm):	58
E (mm):	~
H (mm):	18 - 30
h (mm):	40
S (mm):	20 - 10
T (mm):	12
Y (mm):	~
Number of Sides (No.):	2
Number of Holders (No.):	4
Nett Weight (kg):	2.5



Description

Manufactured from carbonized and hardened steel.
Suitable for 75-110mm centre Height Lathes

Features

- All bearing surfaces are precision ground to ensure rigidity
- Handy lathe accessory for tool rooms and general engineering shops
- Ease of operation cuts set-up time by 90%
- No shims are required to adjust tools to correct centre height
- Easily fitted to most small centre lathes
- Please Note:
- Some machining maybe required to suit your lathe
- 'S' dimension represents bush OD & ID

Includes

- 3 x Square Tool Holders - (14mm opening) for 10mm or 12mm tools
- 1 x Boring Bar Holder - with Vee
- 1 x Socket Wrench & Allen keys
- 20mm to 10mm Mounting bush

Optional Accessories

- Holders - L280A

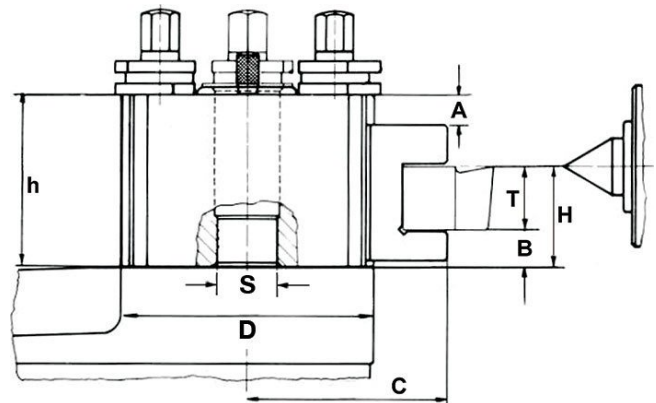

Product Brochure For L280

Recommended Accessories

L280A

Quick Change Toolpost Holder - Std



L687

Opti-Turn Bench Lathe

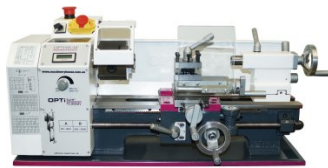

L160

Bench Lathe



L072

HSS Turning Tool Set - 4 piece



L0055

Lathe Turning Tool Kit - 5 piece
Insert Type



L0099

Lathe Turning Tool Kit - 7 piece
Insert Type

