

## Product Brochure For L201D

### Centre Lathe - AL-1324

Ø330 x 600mm Turning Capacity - Ø40mm Spindle Bore  
Includes Digital Readout System

**Ex GST**                      **Inc GST**  
**\$16,776.00**      **\$19,292.40**



ORDER CODE:	L201D
MODEL:	AL-1324
Swing Over Bed (mm):	330
Distance Between Centres (mm):	600
Spindle Bore (mm):	40
Swing In Gap (mm):	~
Swing Over Cross-slide (mm):	200
Digital Readout System Fitted:	Yes
Quick Change Toolpost Fitted:	Optional
Leadscrew Covers Fitted:	Yes
Taper Turning Attachment:	Optional
Coolant System:	Yes
Tool Height To Suit (mm):	16
Centre Height (mm):	165
Spindle Nose Size or Type:	D1-4 Camlock
Bed Width (mm):	190
Headstock Spindle Taper (MT):	5
Tailstock Taper (MT):	3
Cross Slide Travel (mm):	175
Compound Slide Travel (mm):	100
Leadscrew Type:	Metric
Metric Cross Feed (X-Axis) (mm/rev):	0.034 - 0.468
Imperial Cross Feed (X-Axis) (inch/rev):	~
Metric Longitudinal Feed (Z-Axis) (mm/rev):	0.068 - 0.936
Imperial Longitudinal Feed (Z-Axis) (inch/rev):	~
Metric Thread Steps & Pitch (No. / mm):	30(0.4 - 7.0)
Imperial Thread Steps & TPI (No. / TPI):	32(4 - 56)
3 Jaw Chuck Diameter (mm):	160
4 Jaw Chuck Diameter (mm):	200
Spindle Steps / Speeds (No. / rpm):	18 (50 - 2000)
Motor Power (kW / hp):	2.25 / 3
Voltage / Amperage (V / amp):	415
Nett Weight (kg):	580



### Description

Manufactured in Taiwan

### Features

- Tool room quality precision lathe, Made in Taiwan and have been sold for over 20 years
  - 2-Axis digital readout system fitted
  - Gear drive headstock for quick change of spindle speeds
  - Nachi Japanese made bearings supporting headstock spindle
  - Stand increasing rigidity and reducing vibration
  - Precision 'V'-beds are hardened and ground, incorporating a rigid webbed casting
  - Foot operated spindle brake with safety cut out switch
  - Slide out front swarf tray for easy cleaning
  - Chuck guard fitted fitted with micro switch
  - Leadscrew cover ensures swarf not reaching clasp nut
  - Change gears for metric and imperial thread cutting
  - Oil sight glass for head stock and gearbox
  - Adjustable taper roller bearings support the spindle
  - Overload clutch mechanism on auto power feed
  - Overload protection on drive motor and coolant system
- 3HP/415V motor, 18-speed (50 - 2000rpm)

## Product Brochure For L201D

- Enclosed quick action gearbox for thread cutting and auto feeding
- Powered longitudinal and cross feeds
- D1-4 camlock spindle for quick chuck changes and safe reverse-direction turning. ISO standard
- Dual calibrated dials
- Coolant system with flexible hose
- Slide out swarf tray

### Includes

- 2-Axis digital readout system fitted
- 3-jaw chuck with reverse jaws
- 4-jaw chuck
- Faceplate
- Fixed Steady
- Travelling steady
- Chuck guard
- Concertina leadscrew covers
- Slide out front swarf tray
- Dead centre
- Thread chasing dial
- Foot brake
- Coolant system
- Rear splash guard
- Instruction booklet

### Specific Features



Left View

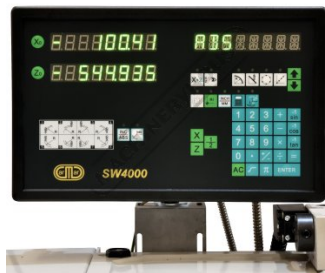

2 Axis Digital Readout



Chuck Guard with Safety Micro



Safety Chuck Guard Up



Headstock



Spindle Speed Levers



Enclosed Quick Change Gearbox

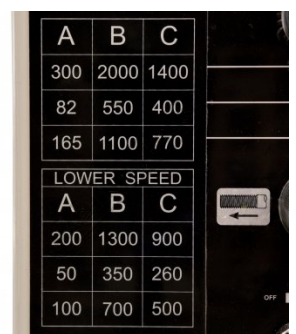

Spindle Speed Chart

Product Brochure For L201D

PITCH		MM	
U	S	0.1	
T	S	0.125	
R	S	0.15	
Q	S	0.2	
P	S	0.25	
O	S	0.3	
N	S	0.375	
M	S	0.45	
L	S	0.5	
K	S	0.6	
J	S	0.75	
I	S	1.0	
H	S	1.25	
G	S	1.5	
F	S	2.0	
E	S	2.5	
D	S	3.0	
C	S	4.0	
B	S	5.0	
A	S	6.0	
AD		3.2 3.6 4.0 4.5 5.0 5.6 6.3 7.0	
BD		1.6 1.8 2.0 2.2 2.5 2.8 3.1 3.5	
AC		0.8 0.9 1.0 1.2 1.25 1.4 1.5 1.75	
BC		0.4 0.45 0.5 0.6	
TPI		INCHES	
U	S	10	
T	S	12.5	
R	S	15	
Q	S	20	
P	S	25	
O	S	30	
N	S	37.5	
M	S	45	
L	S	50	
K	S	60	
J	S	75	
I	S	100	
H	S	125	
G	S	150	
F	S	200	
E	S	250	
D	S	300	
C	S	400	
B	S	500	
A	S	600	
AD		4 4.5 5 5.5 6 6.5 7	
BD		8 9 10 11 12 13 14	
AC		16 18 19 20 22 24 26 28	
BC		32 36 38 40 44 48 52 56	
FEED		MM	
X		Y	Z
PAD	0.544	0.752	0.936
PBD	0.272	0.376	0.468
PAC	0.138	0.188	0.234
PBC	0.068	0.094	0.117

Thread-Feed Chart



Hi Low Switch



Foot Brake



Sliding Drip Tray for Swarf Removal



3 Jaw Chuck



Fixed and Travelling Steadies



Leadscrew Cover Front

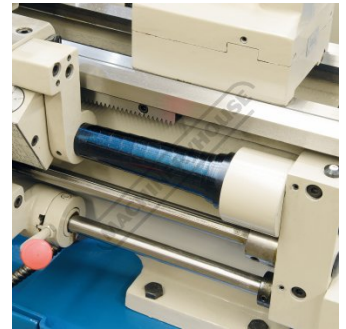

Leadscrew Cover Rear



Flexible Coolant Hose

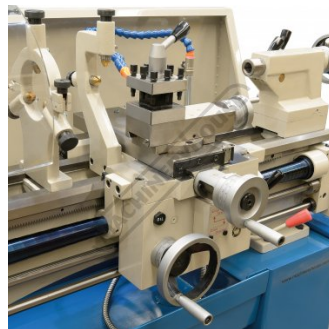

Saddle Left View

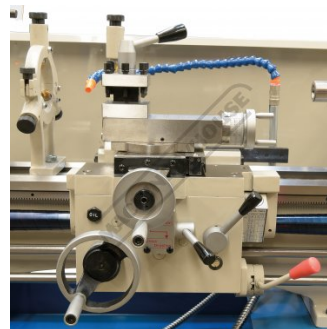

Saddle Front View



Saddle Right View



Toolpost



Thread Chasing Dial

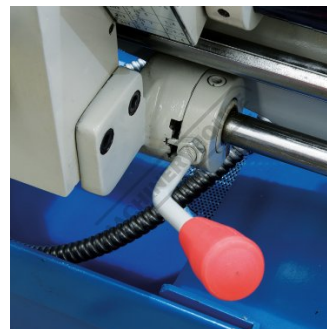

Forward Reverse Spindle Lever



Feed Levers

Product Brochure For L201D



Swivel Compound Slide



Cross Slide Hand Wheel

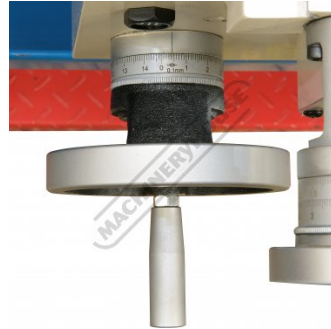

Saddle Hand Wheel

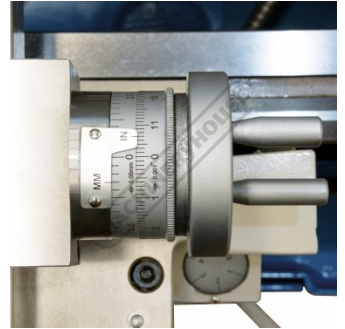

Compound Slide Hand Wheel

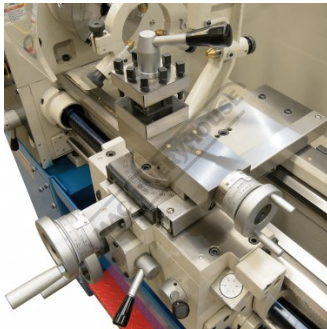

Compound Slide



Tailstock

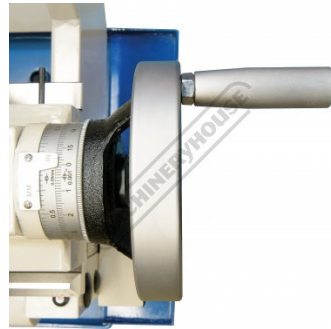

Tailstock Hand Wheel



Tailstock Quill Graduations



Tailstock Horizontal Adjustment



Hardened and Ground Bedways



Bed Drip tray



Toolbox

Product Brochure For L201D

**Recommended Accessories**

L258  
Taper Turning Attachment



L277  
Vertical Mill Slide



C980  
5C Collet Lathe Adaptor



L295  
Quick Change Toolpost



L017  
Right Hand Turning Tool Holder



L018  
Left Hand Turning Tool Holder



L044  
Right Hand Turning Tool Holder



L045  
Left Hand Turning Tool Holder



Product Brochure For L201D

**L0077**  
Lathe Turning Tool Kit - 7 piece  
Insert Type



**L451**  
Lathe Turning Tool Kit - 3 piece  
Insert Type



**L457**  
Lathe Threading Tool Kit - Insert  
Type



**L465**  
Professional Lathe Parting Tool  
Kit - Insert Type



**C052**  
3MT Live Centre



**C045**  
3MT Pipe Centre - 70° Cone



**L076**  
Knurling Tool Holder Kit



**C290**  
Heavy Duty Drill Chuck - Keyed  
Type



**C294**  
Industrial Drill Chuck - Keyless  
Type



**D443A**  
3MT x JT3 Drill Chuck Arbor



**D126**  
Metric 135° Precision HSS Drill  
Set - 170 Pieces



**D1282**  
Imperial 135° Precision HSS  
Drill Set - 29 Piece



Product Brochure For L201D

**S090A**  
Soluble Metal Cutting Fluid - 1 Litre



**S090**  
Soluble Metal Cutting Fluid - 5 Litre



**S076**  
Cutting Tool Lubricant Fluid - 500ml



**S077**  
Drilling, Tapping & Cutting Tool Lubricant Spray - 400g



**S074**  
Cutting Tool Lubricant Paste - 500g



**L341**  
Fitting and Machining Technical Book

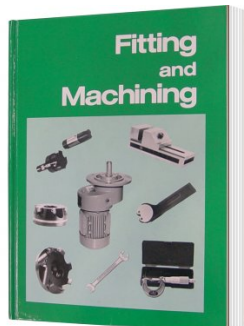

**L345**  
Handy Workshop Tips & Techniques - 1st Edition

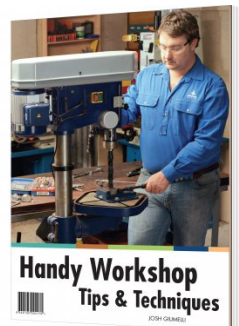

**L3455**  
Professional Sheet Metal Fabrication Book

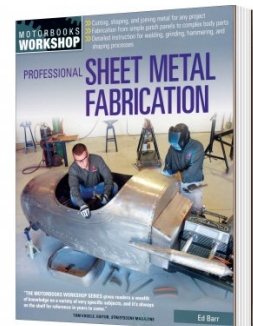

**L300**  
Magnetic Swarf Remover



**M9991**  
Magnetic Floor Sweeper



**M800**  
Rubber Mat - Anti-Fatigue



**M805**  
Rubber Mat - Anti-Fatigue

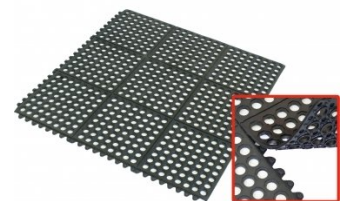

Product Brochure For L201D

---

O043  
Rust & Corrosion Preventive



O042  
General Purpose Lubricant & Corrosion Inhibitor



O044  
Rust & Corrosion Preventive

