

Product Brochure For H9086

## Adjustable Hand Lever - LHF-80-M10

Packet QTY 2

M10X1.5 Thread - Handle 78mm long

**Ex GST**  
**\$36.00**

**Inc GST**  
**\$41.40**



ORDER CODE:	H9086
Brand:	H9086
Wheel Diameter (mm):	HAFCO
Handle Type:	-
Handle Size (mm):	Lever
Screw Length (mm):	78
Outside Thread:	-
Internal Thread:	~
Pack QTY:	M10 x 1.5P



### Description

The Adjustable Hand Lever is designed for applications where space is constrained and components have to be clamped at a particular lever angle. The lever disengages and can be swivelled to the desired clamping position.

### Features

- Handle made from Zinc Alloy

Product Brochure For H9086

Female Thread -Adjustable Hand Levers

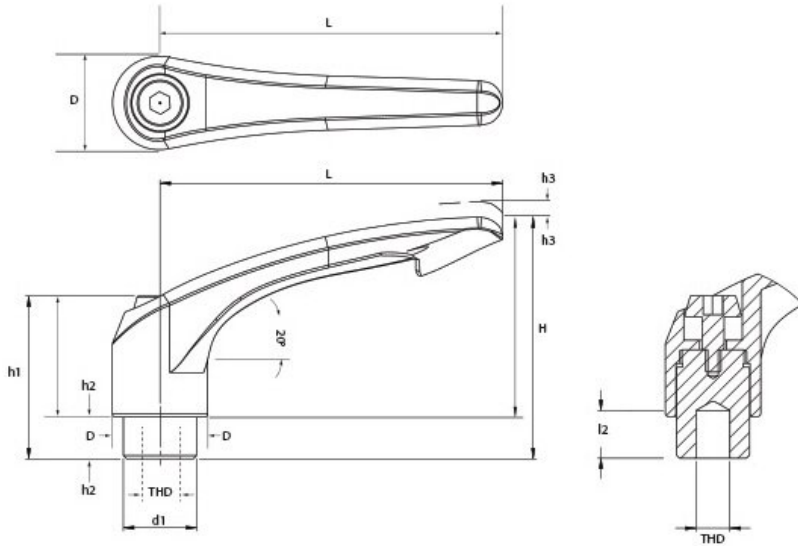

All measurements in mm & Kgs

Order Code	Model No.	L	THD	I2	H	h1	h2	h3	D	d1	Weight
H9082	LHF-45-M6	45	M6 x 1.0	11	40	25	5	4	13.5	10	0.03
H9084	LHF-63-M8	63	M8 x 1.25	14	45	31.5	7.5	3.5	18	13.5	0.07
H9086	LHF-80-M10	80	M10 x 1.5	15	55	36.5	9	4	21.5	16	0.12
H9088	LHF-90-M12	90	M12 x 1.75	20	70	43.5	12	5	24	19	0.17

Specific Features



Top