

Product Brochure For H9078

Adjustable Hand Lever - LHM-90-M12

Packet QTY 2

M12X1.75 Thread - 50MM long

Ex GST
\$40.00

Inc GST
\$46.00



ORDER CODE:	H9078
Brand:	H9078
Wheel Diameter (mm):	HAFCO
Handle Type:	-
Handle Size (mm):	Lever
Screw Length (mm):	92
Outside Thread:	50
Internal Thread:	M12 x 1.75P
Pack QTY:	~



Description

The Adjustable Hand Lever is designed for applications where space is constrained and components have to be clamped at a particular lever angle. The lever disengages and can be swivelled to the desired clamping position.

Features

- Handle made from Zinc Alloy

Product Brochure For H9078

Male Thread -Adjustable Hand Levers

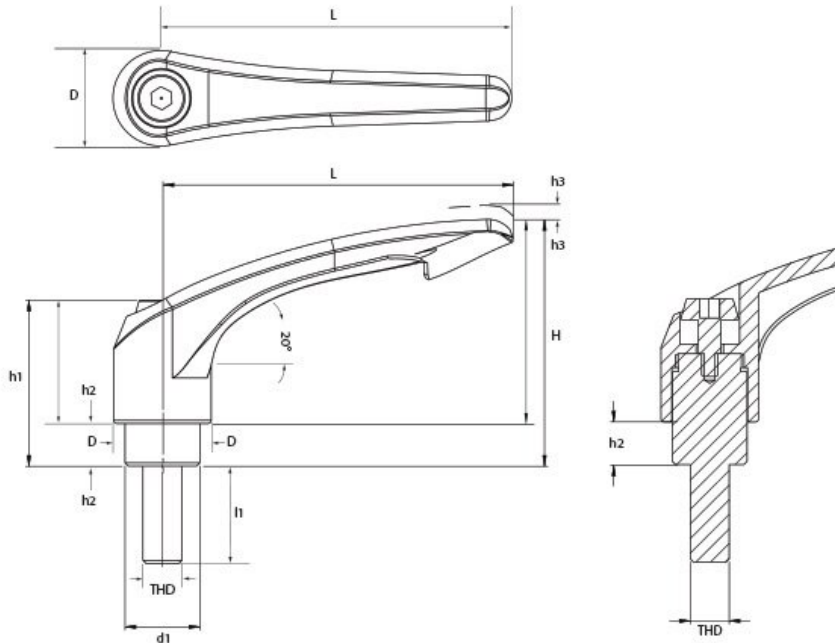

All measurements in mm & Kgs

Order Code	Model No.	L	THD	l1	H	h1	h2	h3	D	d1	Weight
H9072	LHM-45-M6	45	M6 x 1.0	40	40	25	5	4	13.5	10	0.04
H9074	LHM-63-M8	63	M8 x 1.25	40	45	31.5	7.5	3.5	18	13.5	0.09
H9076	LHM-80-M10	80	M10 x 1.5	50	55	36.5	9	4	21.5	16	0.15
H9078	LHM-90-M12	90	M12 x 1.75	50	70	43.5	12	5	24	19	0.22

Product Brochure For H9078

Specific Features



Top