

Product Brochure For H9018

Aluminium Handwheel - Revolving Handle

Ø100mm

Aluminium centre supplied standard with 8mm bore

Ex GST
\$38.00

Inc GST
\$43.70



ORDER CODE:	H9018
Brand:	H9018
Wheel Diameter (mm):	HAFCO
Handle Type:	100
Handle Size (mm):	Revolving
Screw Length (mm):	65
Outside Thread:	~
Internal Thread:	~
Pack QTY:	~



Description

Ø100mm die-cast aluminium handwheel
65mm revolving type phenolic handle
Black coloured finish
Threaded grub screw to secure handwheel

Features

- Revolving phenolic handle
- Threaded grub screw
- Aluminium centre supplied standard with 8mm bore that requires machining to suit your application.

Product Brochure For H9018

Aluminium Hand Wheel - Revolving Handle

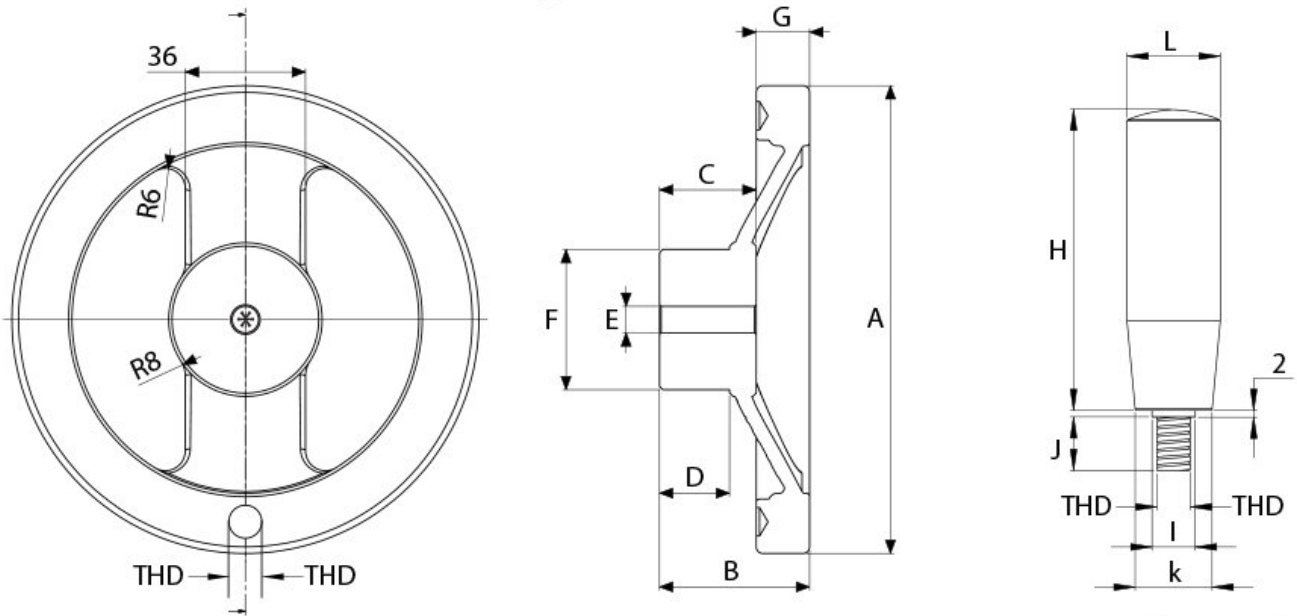

All measurements in mm & Kgs

Order Code	Model No.	A	B	C	D	E	F	G	H	I	J	THD	K	L	Weight
H9018	AHW-100	100	34	23	15	8	38	14	65	12	12	M8	19	23	0.30
H9019	AHW-125	125	41	25	16	8	40	15	65	12	12	M8	19	23	0.40
H9021	AHW-160	160	46	30	19	8	42	18	80	13	16	M10	21	26	0.68
H9022	AHW-200	200	55	38	18	10	49	21	90	16	13	M10	23	28	1.06

* Aluminium centre supplied standard that requires machining to suit your application

Product Brochure For H9018

Specific Features



Side View



Rear View



Bottom View



Grub Screw Attachment