

Product Brochure For H9012

Folding Handwheel - ABS

Ø125mm

Steel centre supplied standard with 8mm bore

Ex GST
\$50.00

Inc GST
\$57.50



ORDER CODE:	H9012
Brand:	H9012
Wheel Diameter (mm):	HAFCO
Handle Type:	125
Handle Size (mm):	Folding
Screw Length (mm):	65
Outside Thread:	~
Internal Thread:	~
Pack QTY:	~



Description

Ø125mm ABS handwheel with steel centre
65mm folding type phenolic handle
Black coloured finish
Threaded grub screw to secure handwheel

Features

- Foldable Handle
- Threaded grub screw
- Steel centre supplied standard with 8mm bore that requires machining to suit your application.

Product Brochure For H9012

Hand Wheel - Folding Handle

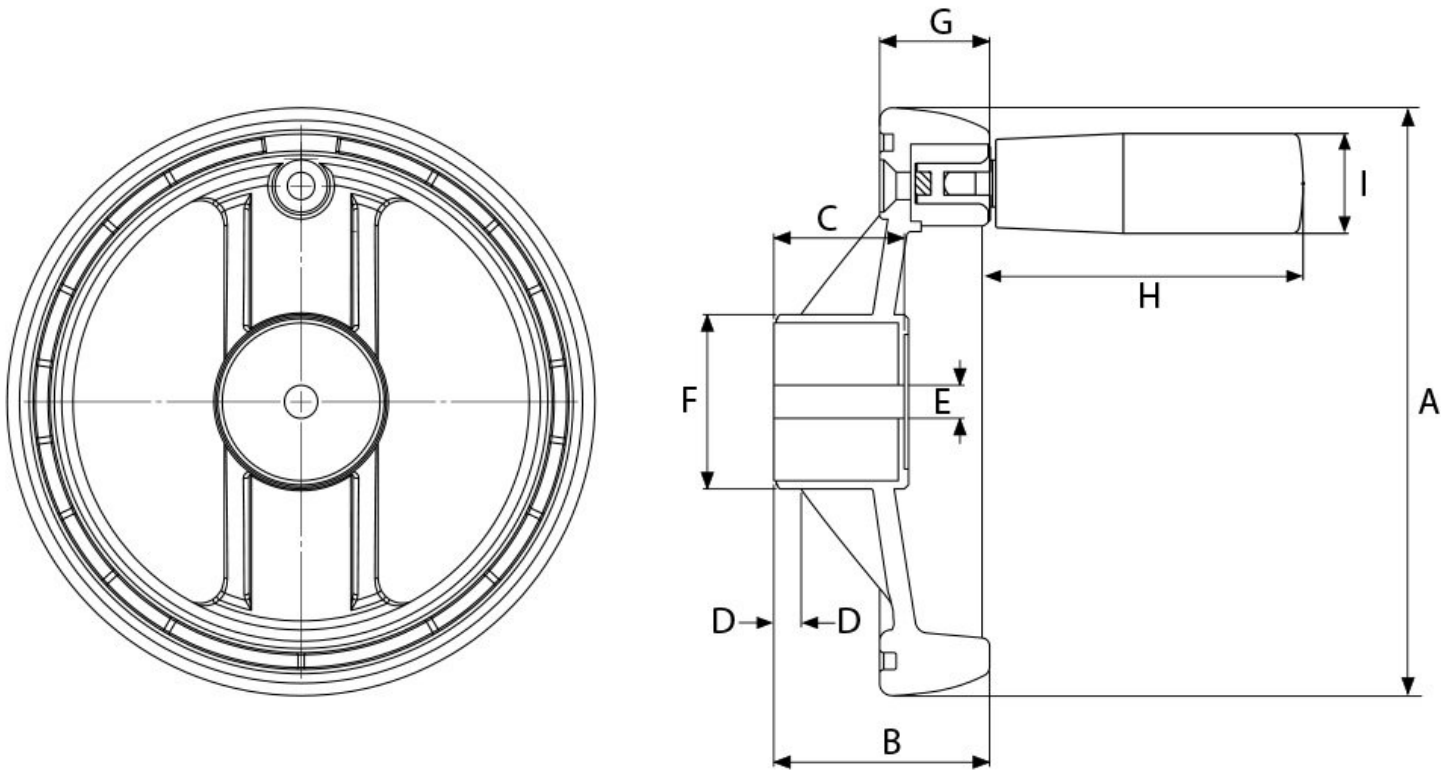

All measurements in mm & Kgs

Order Code	Model No.	A	B	C	D	E	F	G	H	I	Weight
H9010	PHW-80F	80	40	24.5	3	6	30	19.5	57	19	0.19
H9011	PHW-100F	100	40	24.5	3	8	36	21.5	67	21	0.28
H9012	PHW-125F	125	47	26.5	3	8	39	25.5	86	23	0.42

Product Brochure For H9012

Specific Features



Handle Folded Flat



Side View



Rear View



Bottom View



Grub Screw Attachment