

Product Brochure For H9010

Folding Handwheel - ABS

Ø80mm

Steel centre supplied standard with 6mm bore

Ex GST
\$34.00

Inc GST
\$39.10



ORDER CODE:	H9010
Brand:	H9010
Wheel Diameter (mm):	HAFCO
Handle Type:	80
Handle Size (mm):	Folding
Screw Length (mm):	40
Outside Thread:	~
Internal Thread:	~
Pack QTY:	~



Description

Ø80mm ABS handwheel with steel centre
40mm folding type phenolic handle
Black coloured finish
Threaded grub screw to secure handwheel

Features

- Foldable Handle
- Threaded grub screw
- Steel centre supplied standard with 6mm bore that requires machining to suit your application.

Product Brochure For H9010

Hand Wheel - Folding Handle

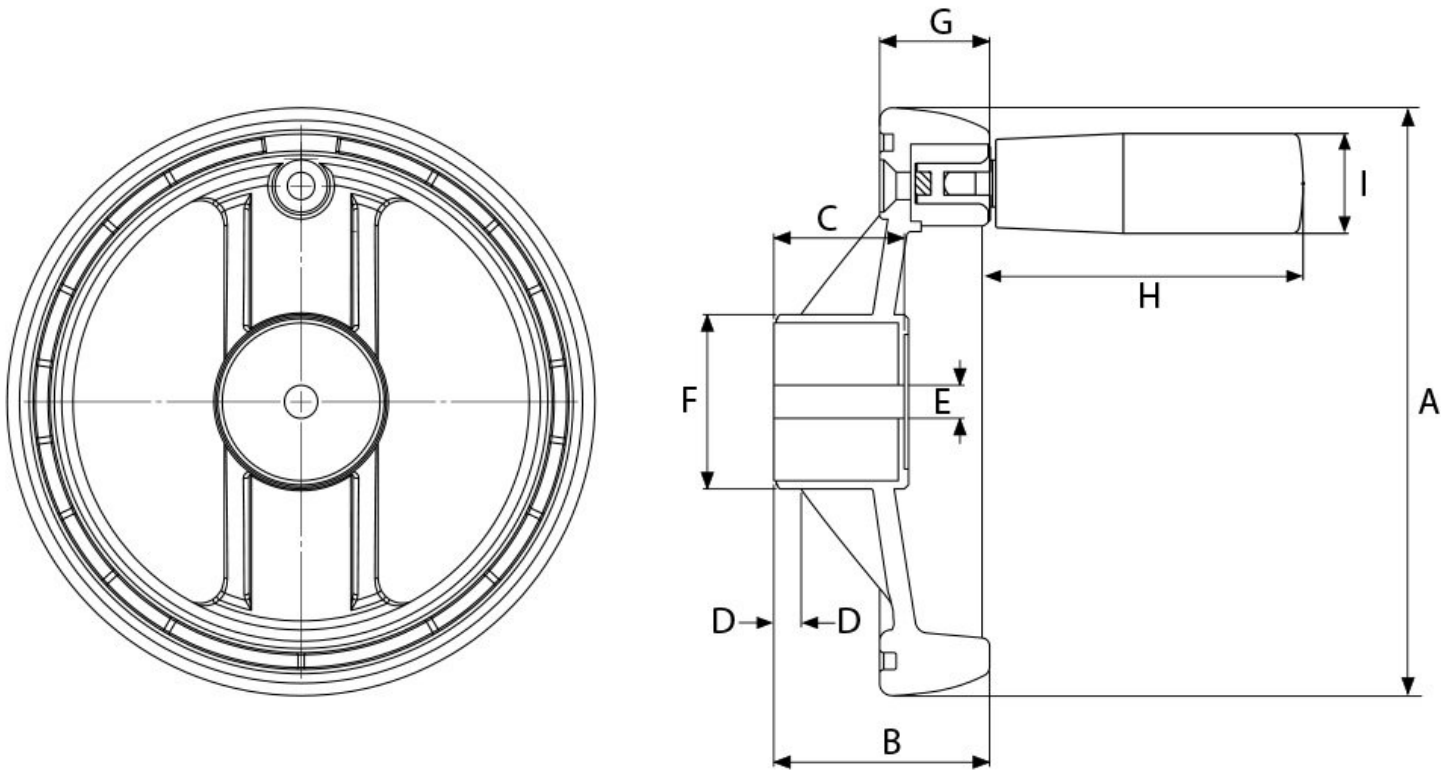

All measurements in mm & Kgs

Order Code	Model No.	A	B	C	D	E	F	G	H	I	Weight
H9010	PHW-80F	80	40	24.5	3	6	30	19.5	57	19	0.19
H9011	PHW-100F	100	40	24.5	3	8	36	21.5	67	21	0.28
H9012	PHW-125F	125	47	26.5	3	8	39	25.5	86	23	0.42

Product Brochure For H9010

Specific Features



Handle Folded Flat



Side View



Rear View



Bottom View



Grub Screw Attachment