

Product Brochure For H276

Compact Wire Rope Hoist - CWS-300

300kg Lifting Capacity
24 Metre Lifting Height



Ex GST **Inc GST**
\$2,772.00 **\$3,187.80**

ORDER CODE:	H276
Model:	CWS-300
Brand:	Pacific Hoist
Lifting Capacity (kg):	300
Lifting Height (Metre):	24
Speed (m/min):	13
Pendant Control Length (Metre):	10
Wire Rope Diameter (mm):	Ø4.8
Motor Output (kW):	1.5
Voltage (V):	240
Nett Weight (kg):	17



Description

Designed for use on building sites and multi-storey units, these compact electric rope hoists are also suitable for a wide range of applications in warehouses, storage areas, factories, etc.

Features

- Lightweight and compact design allowing for easy installation
- Automatic upper limit switch, when rope disc touches the limit arm, hoisting is automatically stopped
- Lower overwind limit switch
- Dynamic and mechanical brake providing instant and safe braking
- Convenient 240 volt/single phase power supply
- Sensor arm automatically stops motor if the wire rope is under-wound
- Wire rope with 360° weighted hook with safety latch
- Supplied with 3 metre power lead and industry plug & 10 metre heavy duty IP65 waterproof pendant control

Optional Accessories

- Mounting Arm CRH-0710
- Push Trolley Mount Bracket CRH-0720A

Product Brochure For H276

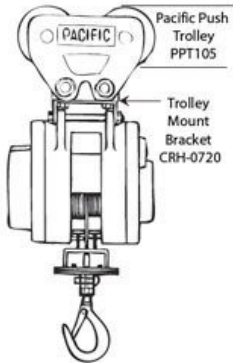
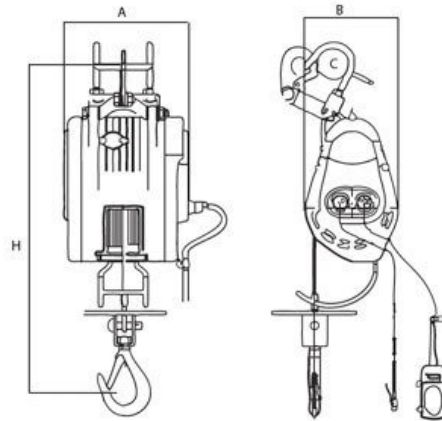
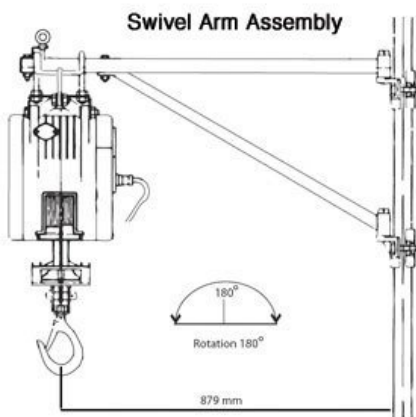

Diagram of optional trolley mount bracket attached to a Pacific twin pin push trolley



Model		CWS-80	CWS-160	CWS-230	CWS-300
Rated Capacity	kg	80	160	230	300
Stock Code		CWS080	CWS160	CWS230	CWS300
Lifting Speed	m/min	30	22	14	13
Motor	kW	0.8	1.2	1.3	1.5
Power Supply		240 Volt 1Ø 50 Hz			
Lifting Height	m	35	40	24	24
Wire Rope	Ømmxm	3.3x36	4x41	5x25	4.8 x 25
Net weight	kg	9	14	15	17
Dimensions mm	A	200	244	244	244
	B	168	182	182	182
	C	Ø55	Ø55	Ø60	Ø60
Head Room	H	605	640	640	640

Product Brochure For H276

Recommended Accessories

C147
Girder Trolley



H300
Round Sling



H316
Flat Sling



H305
Round Sling



H318
Flat Sling



H308
Round Sling



H307
Round Sling



H320
Flat Sling



Product Brochure For H276

H310
Round Sling

H314
Round Sling

H322
Flat Sling

H312
Round Sling



H324
Flat Sling

