

Product Brochure For H2581

Electric Chain Hoist - TECH0106

1 Tonne x 6 Metre Lift
Single speed



On Sale

Ex GST	Inc GST
\$2,700.00	\$3,105.00
\$2,565.22	\$2,950.00

ORDER CODE:	H2581
MODEL:	TECH0106
Capacity (Tonne):	1
Lift Height (Metre):	6
Lift Speed (m/min):	6
Motor Power (W):	1200
Voltage (V):	240



Description

0.5 Mini Hoist, 1 and 2 Tonne Standard Hoists ex stock - re-chain options available

Features

- Load Limited
- Thermal Overload Prevention
- Emergency Stop
- Light weight, compact design with high efficiency motor
- Pressed steel structure, high strength body
- High tensile alloy steel top & bottom hooks
- Grade 80 - Alloy Steel load chain
- Limit switches fitted at top and bottom ends to prevent chain runout
- 240V, 50Hz Single speed Motor 1200W. (Single Phase)
- IP Rating: Hoist IP54 / Control IP65

Optional Accessories

- Available with customisable chain lengths and an optional wireless remote for added convenience (additional costs may apply)

Product Brochure For H2581

Main Dimension of TECH Series Electric Chain Hoist

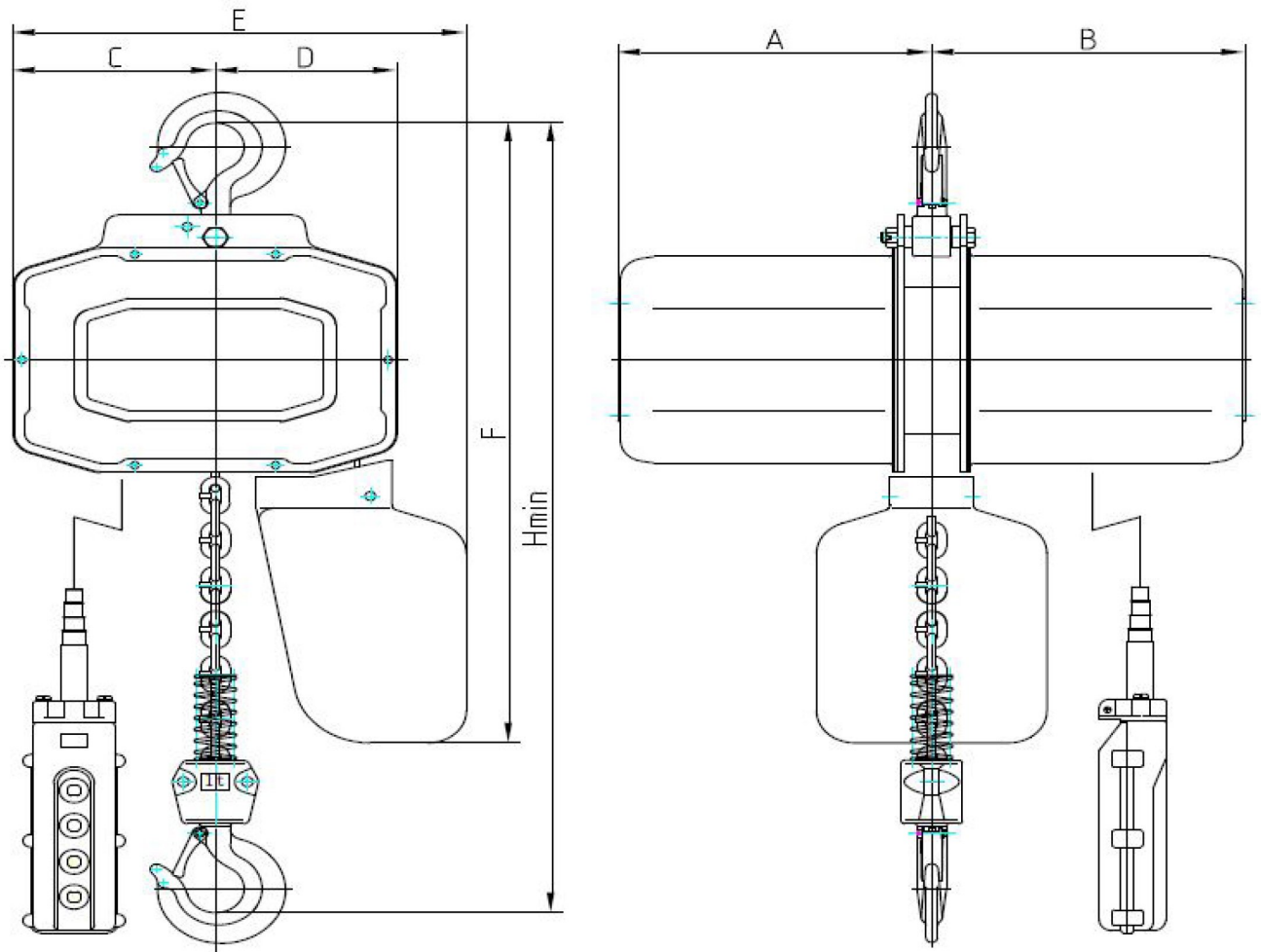

Model	TECH0103 / TECH0106	TECH0203 / TECH0206
A	245	245
B	245	245
C	158	124
D	142	176
E	350	350
F	600	610
H	520	630

Product Brochure For H2581

Recommended Accessories

C147
Girder Trolley



C146
Girder Clamp



H352
13mm 2T Grade S - Lifting Bow Shackle



H350
11mm 1.5T Grade S - Lifting Bow Shackle



H308
Round Slings



H307
Round Slings



H320
Flat Slings



H322
Flat Slings



Product Brochure For H2581

H312
Round Sling



C188
Mobile Girder Rail Gantry



C191
Digital Crane Scale

