

Product Brochure For G612

## Lathe Safety Chuck Guard - LG-8

203mm Centre Height



**On Sale**

Ex GST	Inc GST
<del>\$244.00</del>	<del>\$280.60</del>
<b>\$193.91</b>	<b>\$223.00</b>

ORDER CODE:	G612
MODEL:	LG-8
Guard Type:	Safety Chuck Guard
Material Type:	Steel
Leadscrew Cover Width (mm):	~
Suits Lathe - Distance Between Centres (mm):	~
Suits Lathe Centre Height (mm):	203
Suits Lathe Chuck Size Max. (mm):	Ø250



### Features

- Retro fits to lathe headstock with a 203mm centre height
- Suits up to Ø250mm lathe chucks
- Swivel steel safety chuck guard with handle
- Includes safety chuck guard, mounting bracket with micro switch and wiring
- Micro switch recommended for 12V or 24V
- Installation required by a licensed electrician

Product Brochure For G612

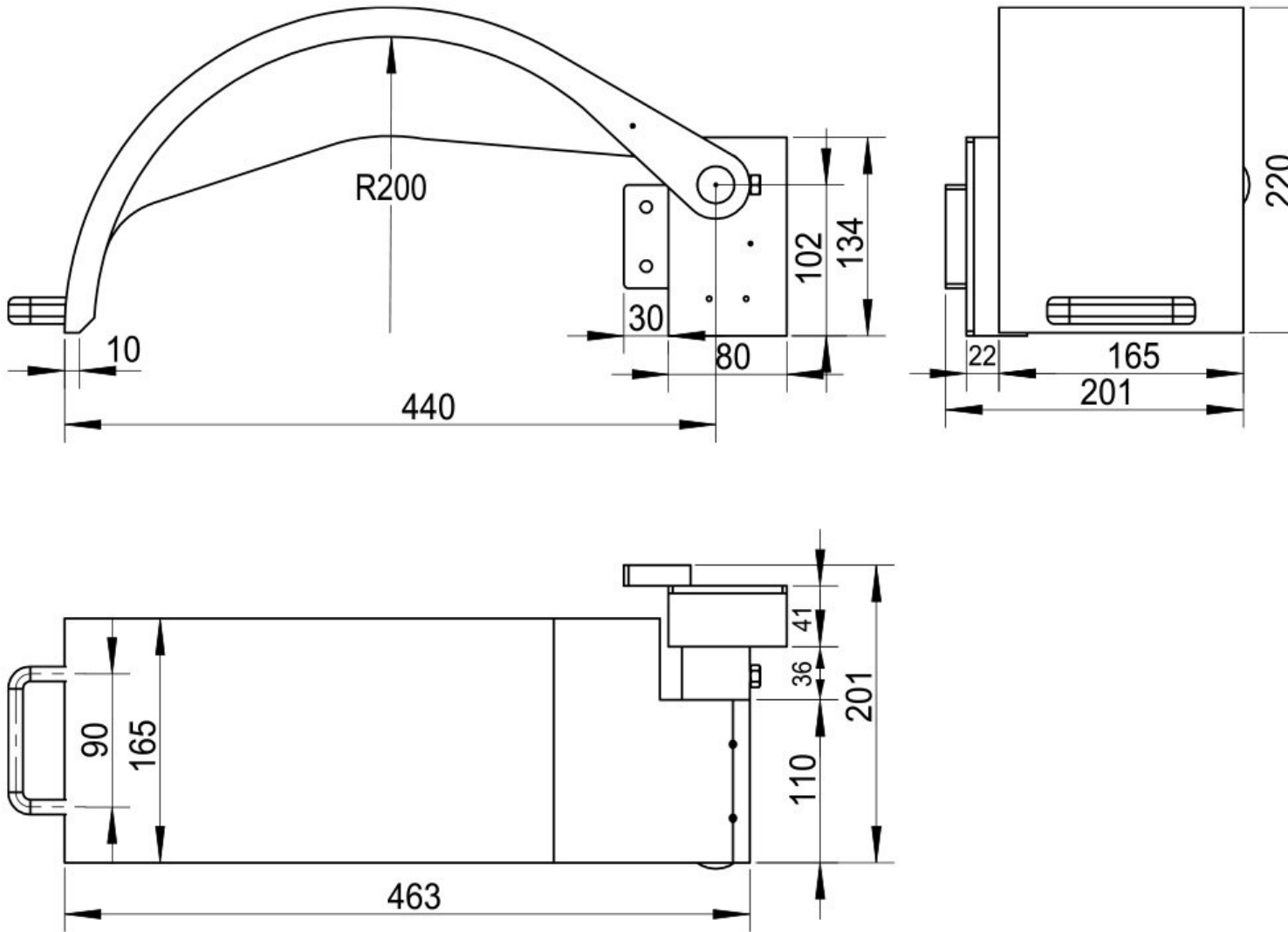

## Product Brochure For G612

---

### Specific Features

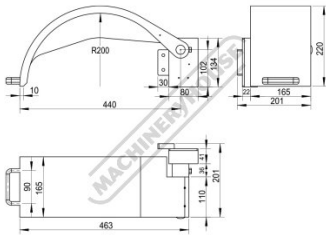

### Dimensions