

Product Brochure For C8558

ER25 Collet

Ø10-Ø9mm
"Made in Taiwan"



On Sale

Ex GST
~~\$26.00~~
\$20.00

Inc GST
~~\$29.90~~
\$23.00

ORDER CODE:	C8558
Type:	ER25
Metric Size (mm):	10 - 9
Imperial Size (inch):	~



Features

- Manufactured to DIN standard
- Collet size covers a range from expanded to compressed
- Collets from 2mm have 1mm of movement
- Collets are listed by their expanded size
- Eg. When ordering an ER32-3 the range is from 3mm expanded to 2mm compressed

Product Brochure For C8558

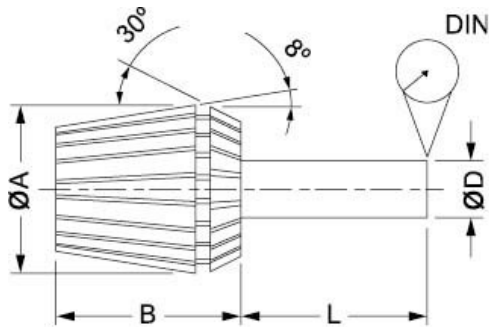

Collet	A	B	L	DIN	RANGE (D)
ER11	11.5	18	6	0.02	0.5-7.0
ER16	17	27	10	0.02	0.5-10.0
ER20	21	31	16	0.02	1.0-13.0
ER25	26	35	25	0.02	1.0-16.0
ER32	33	40	40	0.02	2.0-20.0
ER40	41	46	50	0.03	3.0-26.0

Installation Guide - Please see downloads for full details



Recommended Accessories

C864
25 x 150 x ER25 Collet Chuck - Straight

C861
ER25 Collet Chuck Wrench

T214
BT40 x ER25-70 Collet Chuck

T215
BT40 x ER25-100 Collet Chuck

