

Product Brochure For C408

Industrial Caster Wheel Set - CW-102

Ø100mm Wheels

2 x Fixed, 2 x Swivel/Brake

Ex GST
\$136.00

Inc GST
\$156.40



ORDER CODE:	C408
MODEL:	CW-102
Quantity of Wheels in Pack (No.):	4
Wheel Type:	2 Fixed, 2 Swivel/Brake
Wheel Diameter (mm):	Ø100
Wheel Width (mm):	50
Total Height to Top of Plate (mm):	145
Load Capacity per Wheel (kg):	400
Load Capacity per Set (kg):	
Nett Weight (kg):	11



Description

Industrial quality Ø100mm caster wheels, Tyre is made from 7mm thick polyurethane with an load capacity of up to 400kg per caster.

Features

- Ø100mm x 50mm wide polyurethane wheel
- 2 x fixed wheels
- 2 x swivel wheels with brake
- 400kg each wheel capacity
- Brake also locks wheel from swivelling
- Swivel base incorporates ball bearings
- Ball bearing sealed race on main shaft
- 145mm overall height from base of wheel to top of plate
- Mounting plate 114.5 x 101.5mm with 4 slotted holes

Product Brochure For C408

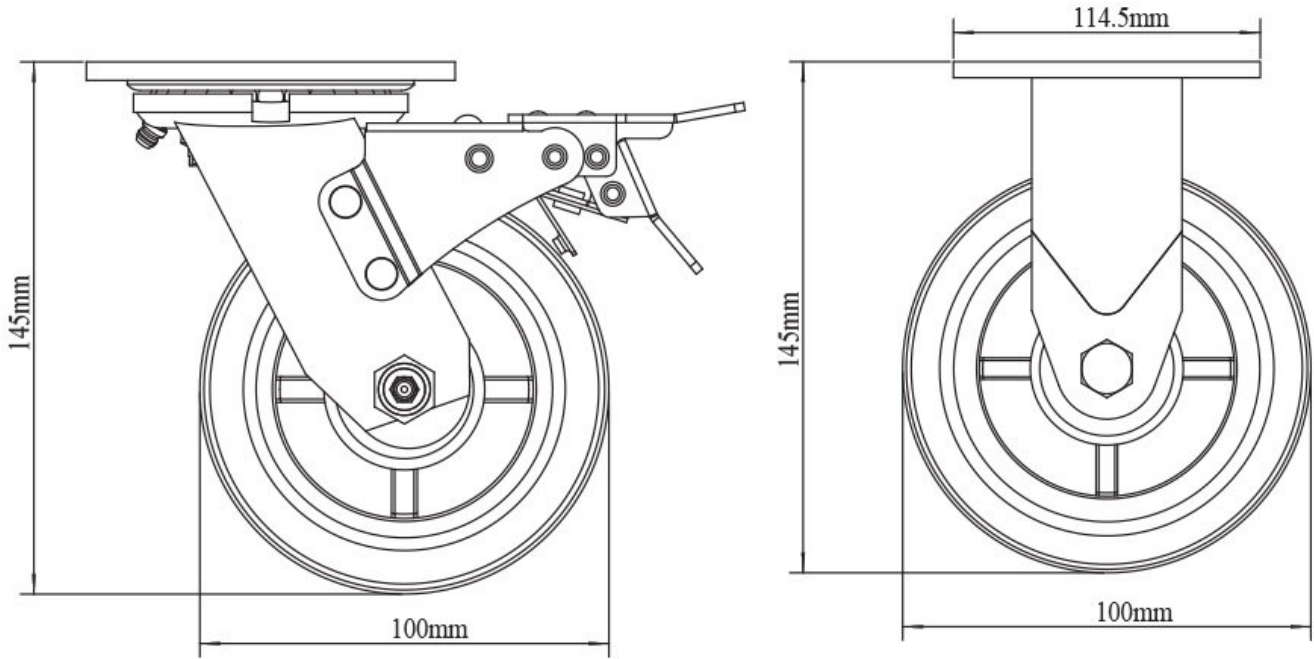

Specific Features



Ball Bearing Base With Greasing Nipple



Swivel Wheel With Brake



Fixed Wheel

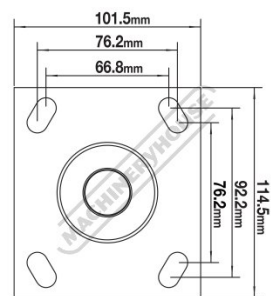

Baseplate dimensions
Baseplate Dimensions

Product Brochure For C408

Recommended Accessories

W08453
750 x 1000mm 1D Welding
Table



W08455
Welding Table



A380
Steel Work Bench - 3 x Lockable
Drawers



A415
Industrial Work Bench



A420
Industrial Work Bench



F298
Stainless Steel Bench with
Splashback



F280
Stainless Steel Island Work
Bench



S014
Industrial Steel Shelving

