

Product Brochure For C4068

## Foot Swivel Caster Wheel - 1 Piece - GD-120F

1000kg Load Capacity

**Ex GST**  
**\$44.00**

**Inc GST**  
**\$50.60**



ORDER CODE:	C4068
MODEL:	GD-120F
Quantity of Wheels in Pack (No.):	1
Wheel Type:	Foot Caster Wheel - Adjustable Stop
Wheel Diameter (mm):	75
Wheel Width (mm):	30
Total Height to Top of Plate (mm):	120
Load Capacity per Wheel (kg):	1000
Load Capacity per Set (kg):	~
Nett Weight (kg):	1.6



### Features

- Suitable for Welding Tables
- Swivel Wheel Mount Bracket
- Adjustable Stop with Integrated thumb spanner for height adjustment
- Anti-vibration NBR foot pad
- 1000kg Load Capacity

### Includes

- 1 Piece

# GD-120F - Dimensions

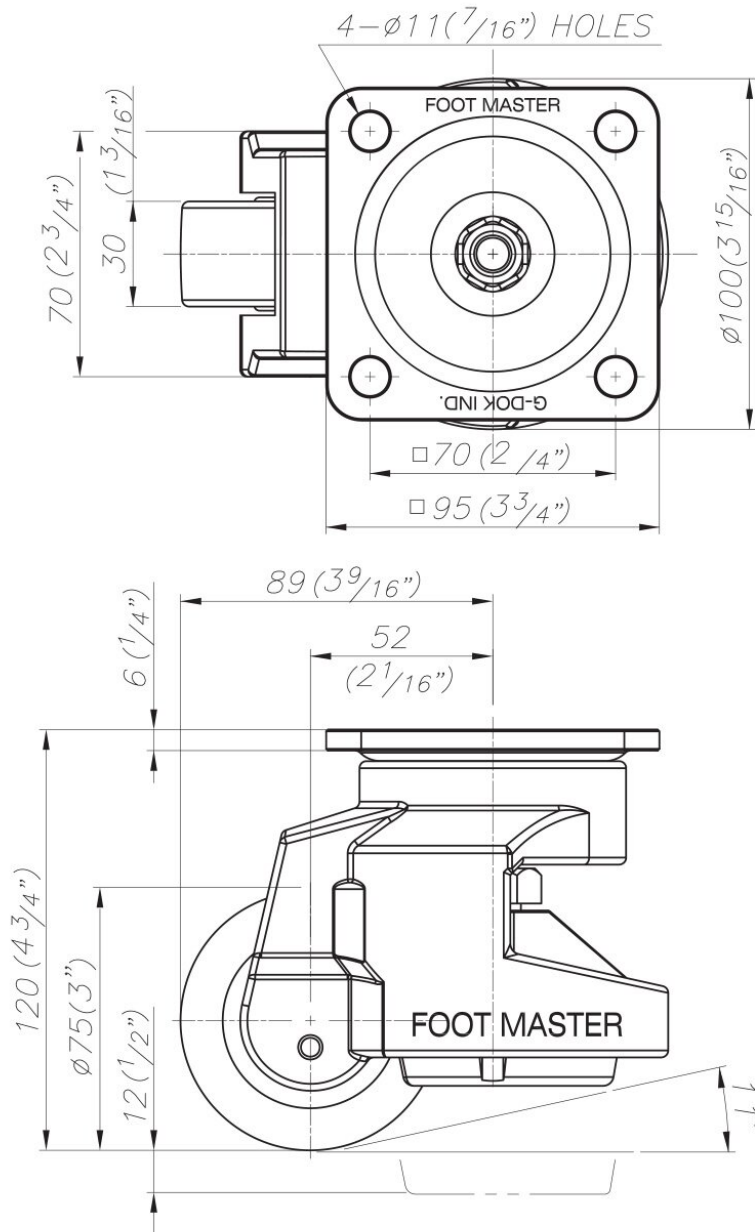

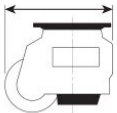
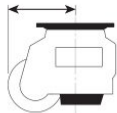
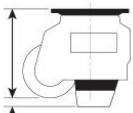
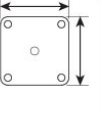
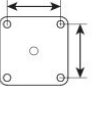
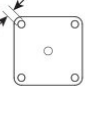
MODEL	Load Capacity / pce kg	 mm	 mm	 mm	 mm	 mm	 mm
GD-120F	1000	141	89	120+12	95x95	70x70	11

## Product Brochure For C4068

---

### Specific Features



Ajustable Stop Wound Down



Ajustable Stop Wound Up

### Recommended Accessories

#### W07720A

2560 x 1250mm BuildPro  
Modular Welding Table -  
Standard Finish

#### W07716A

1960 x 1000mm BuildPro  
Modular Welding Table -  
Standard Finish

#### W07749

BuildPro Levelling Pad for  
Tabletop - 1 Piece

