

Product Brochure For C4064

Foot Swivel Caster Wheel - 1 Piece - GD-80F

500kg Load Capacity

Ex GST
\$30.00

Inc GST
\$34.50



ORDER CODE:	C4064
MODEL:	GD-80F
Quantity of Wheels in Pack (No.):	1
Wheel Type:	Foot Swivel Caster Wheel - Adjustable Stop
Wheel Diameter (mm):	63
Wheel Width (mm):	28
Total Height to Top of Plate (mm):	103
Load Capacity per Wheel (kg):	500
Load Capacity per Set (kg):	~
Nett Weight (kg):	1.04



Features

- Suitable for Welding Tables
- Swivel Wheel Mount Bracket
- Adjustable Stop with Integrated thumb spanner for height adjustment
- Anti-vibration NBR foot pad
- 500kg Load Capacity

Includes

- 1 Piece

GD-80F - Dimensions

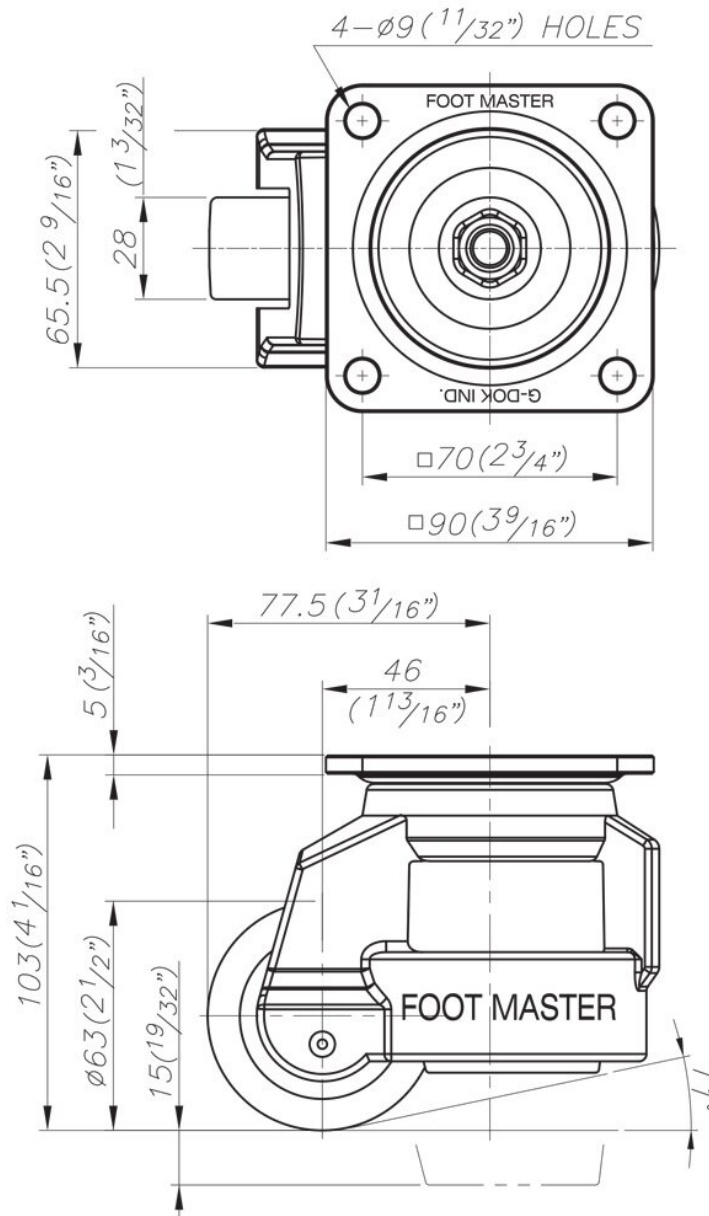

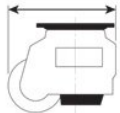
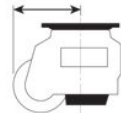
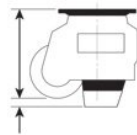
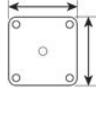
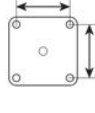
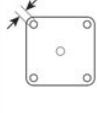
MODEL	Load Capacity / pce kg	 mm	 mm	 mm	 mm	 mm	 mm
GD-80F	500	125	77	102+15	92x92	70x70	9

Product Brochure For C4064

Specific Features



Ajustable Stop Wound Down



Ajustable Stop Wound Up

Recommended Accessories

W07720A

2560 x 1250mm BuildPro
Modular Welding Table -
Standard Finish

W07716A

1960 x 1000mm BuildPro
Modular Welding Table -
Standard Finish

W07749

BuildPro Levelling Pad for
Tabletop - 1 Piece

