

Product Brochure For A423

3 Drawer - Industrial Under Bench Tooling Cabinet - HC-3

565mm Wide x 450mm High
40kg per Drawer

Ex GST
\$354.00

Inc GST
\$407.10



ORDER CODE:	A423
MODEL:	HC-3
Number of Drawers (No.):	3
Drawer Load Capacity (kg):	40
Maximum Total Load Capacity (kg):	~
Includes Backing Panel:	~
Dimensions (W x D x H) (mm):	565 x 580 x 450mm
Nett Weight (kg):	36



Description

The HC-3 cabinet is designed mount under the IWB-40 work bench by using the mounting bracket supplied or it can be just screwed to your existing work bench

Features

- Ideal for garages or workshops
- Heavy duty full extension sliding ball bearing drawers runners with 97% drawer access
- Key lockable drawers with a load capacity of 40kg each

Includes

- Drawer 1 & 2 - 100mm high, load capacity of 40kg and includes steel dividers
- Drawer 3 - 150mm high, load capacity of 40kg and includes steel dividers

Product Brochure For A423

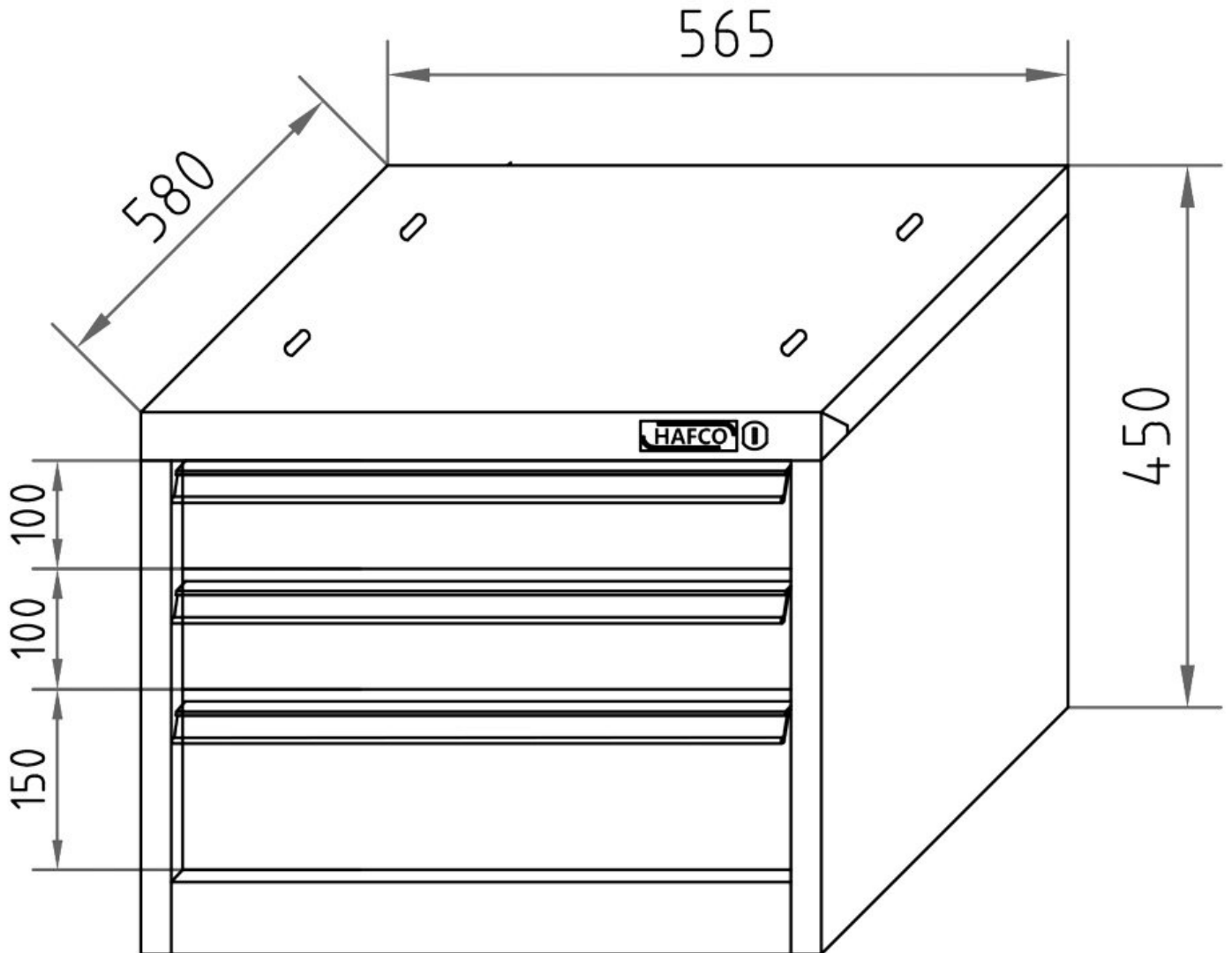

Product Brochure For A423

Specific Features



Front View



Ball Bearing Slides



Draws with Steel Dividers



Key Lockable



Shown With Optional Table

Recommended Accessories

T786
Steel Divider

T786B
Slotted Rail

T787
Steel Divider

T787B
Slotted Rail



Product Brochure For A423

A401
Mobile Work Bench



A415
Industrial Work Bench



A420
Industrial Work Bench



A421
Industrial Work Bench

