

Product Brochure For A330

Rotisserie - ROT8A-360

WLL: 1500Kg

Ex GST **Inc GST**
\$2,746.00 **\$3,157.90**

ORDER CODE:	A330
MODEL:	ROT8A-360
WLL CAPACITY (kg):	1500kg (750kg each Side)
Adjustable Width (mm):	1940-3000
Inside Ring Diameter (mm):	1940
Outside Ring Diameter (mm):	2100
Wheel Diameter (mm):	150
Rotation Angle (Degrees):	360 (6 degree increments)
Weight (kg):	300



Description

The New Metalmaster ROT8A-360 Rotisserie is a game-changer, in our eyes, it's the ultimate in automotive body repair. The innovative design allows you to perform all your body repair work and spray painting in one convenient mounting frame. The unique design allows you to not only rotate a full 360 degrees, while providing easy access to all the hard to get at spots of your vehicle, but the brilliance in the modular design is the removable segments giving you the ability to move the whole assembly through a low clearance opening such as domestic garage doors.

The Metalmaster ROT8A-360 with its easy-to-use features make repairs easier and more efficient than ever before. making it a must-have for any car enthusiast or mechanic looking to make their restoration project a success.

Features

- Designed & developed in Australia with leading automotive craftsmen.
- Modular design to suit low clearance openings such as most standard garage doors.
- Indexable rotation with locking points every 6 degrees of rotation.
- Space saving design with no overhang past chassis once mounted.
- Heavy duty Ø150mm castor wheels with brakes for easy movement.
- Adjustable cross beam to assist with load balancing for easy & safe rotation.
- Lifting & tie down points for moving / loading & unloading.
- Easy pack away design.

Product Brochure For A330

Specific Features

360° ROTATION

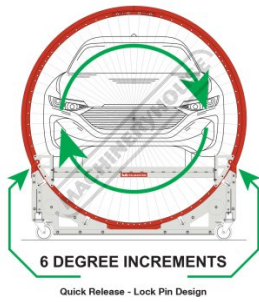

360 Rotation in 6 Degree Increments

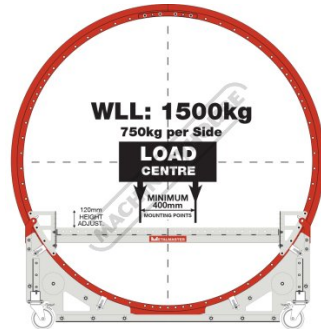

1500kg Total Capacity 750kg Per Side

MODULAR DESIGN

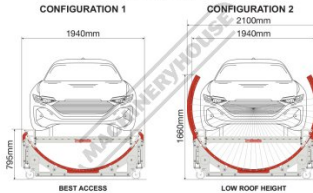

Modular Design Configurations 1-2

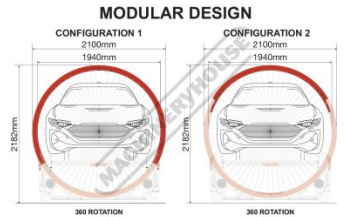

Modular Design Configurations 1-2

ADJUSTABLE WIDTH

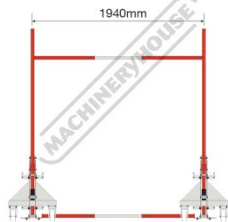

Min Adjustable Width

ADJUSTABLE WIDTH

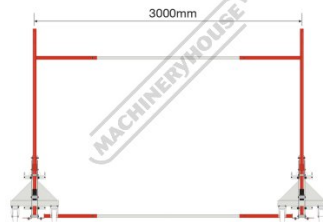

Max Adjustable Width

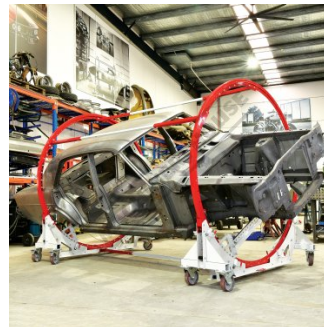

Shown with Car Body



Shown with Car Body Front Low View

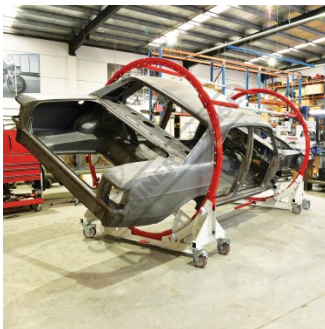

Shown with Car Body Rear View

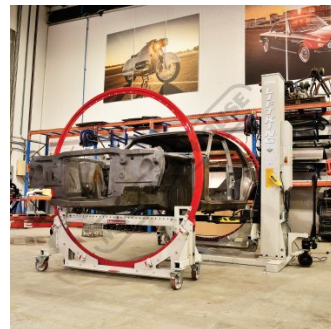

Seek Professional Help When Mounting



Action Shot Welding



Action Shot Welding 2

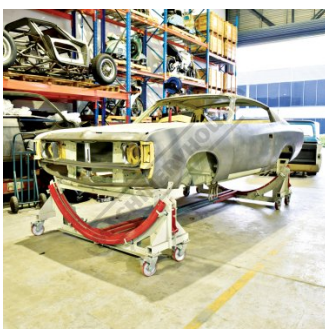

Charger Front View

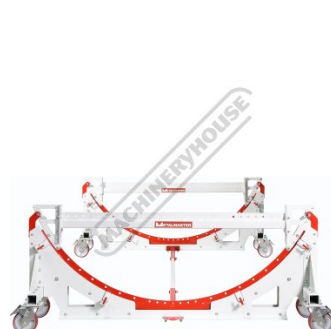

Configuration 1 - Rings Removed



Configuration 1 - with all Rings



Configuration 2 - with Top Ring and Spacer Bars Removed

Product Brochure For A330



Configuration 2 - with Top Ring Removed



Configuration 2 - with all Rings



Min Width 1926mm



Max Width 3000mm



Side View



360 Rotation in 6 Degree Increments



Pin Safety Locks



Adjustable Guide Rollers



Swivel Brake Wheels



Storage Ring Compartments